

DIGITAL BURNER CONTROLLER

DBC2000 SERIES

PRODUCT HANDBOOK



2. FEATURES

- Employs a plug-in mounting method
- Uses a microprocessor to improve performance
- Status and fault indication by indicator LEDs
- A 4-wire firing rate switching circuit controls an air damper motor or other auxiliary equipment during start-up of the burner.
- Safe start check before and during pre-purge
- Dual flame amplifier for UV, IR or flame rod sensor
- Automatic recycle once per 24h of uninterrupted heat demand.
- Frontal jack plug (Ø 3.5mm) to read the flame signal with a microampere meter.
- An electrical sub base lock (reset and safety limit terminals are swapped) to avoid that a Standard model is used systems wired for an Enhanced or Ultimate model. The DBC2000 cannot start then.
- Safety shutdown occurs on
 - malfunction of the burner controller
 - failure to ignite the pilot burner or main burner
 - loss of flame during run period
 - opening of air flow switch during pre-purge, start-up, run and post-purge period
 - flame signal detection during standby or pre-purge period
- Integrated Valve Proofing System (Enhanced and Ultimate models only)
- Remote bus communication (Ultimate model only)

1. APPLICATION

The Honeywell DBC2000 is a microprocessor-based integrated burner controller for automatically fired gas, oil or combination fuel industrial single burner power burner applications. The DBC2000 system consists of the relay module and wiring subbase. The DBC2000 Standard Model provides the minimum requirements to control an industrial burner system, such as automatic burner sequencing, flame supervision, system status indication, system or self-diagnostics and troubleshooting. The DBC2000 Enhanced Model includes an integrated Valve Proofing System, whilst the Ultimate model includes bus communication on top of this.

The DBC2000 is programmed to provide a level of safety, functional capability and features beyond the capacity of conventional controls.

Contents

1. Application	1
2. Features	1
3. Specifications	2
4. Dimensions	5
5. Installation and wiring	6
6. Operation	12
7. Trouble shooting	14
8. Approvals and Maintenance	23
Appendix: VPS calculation and diagrams	25



Important note:

Subject to changes without notice.

Please check our web site
<http://hic.emea.honeywell.com>
 for the most recent version of this document.

All rights reserved.

3. SPECIFICATIONS

Table 1: Model Selection Guide

Model	Description / Application	Supply voltage
DBC2000E10xx (*)	Standard model	115V or 230V (see detailed specs on page 4)
DBC2000E20xx (*)	Enhanced model	
DBC2000E30xx (*)	Ultimate model (future release)	
The Enhanced Model includes a Valve Proofing System. The Ultimate model includes both remote bus communication and a Valve Proofing System.		

(*) xx depends on supply voltage and timings. For exact model number, please refer to product selection matrix of technical catalogue on <http://products.ecc.emea.honeywell.com/europe>.

Table 2: Sequence timing Standard Model

Waiting for AFS	Waiting for HF	Pre-purge	Ignition	Pilot-only	Main trial	Main stabilization	Post-purge	Flame failure response
300s (max)	300s (max)	35s ¹⁾	3s	5s	3s ²⁾	4s ²⁾	15s ³⁾	1s (max)

¹⁾ Default pre-purge time is 35s. Other timings on request, by OS number selection.

²⁾ Set to 0s. when DBI function is enabled (terminal 22 jumpered to line voltage).

³⁾ Set to 0s. when "no post-purge" feature is enabled (terminal 12 jumpered to line voltage).

Sequence at flame failure: immediate lock out

Table 2a: Sequence timing Enhanced and Ultimate Models

Waiting for AFS	Waiting for HF	Pre-purge	Ignition	Pilot-only	Main trial	Main stabilization	Post-purge	Flame failure response
300s (max)	300s (max)	35s ¹⁾	3s	5s	3s ²⁾	4s ²⁾	15s ³⁾	1s (max)

¹⁾ Default pre-purge time is 35s. Other timings on request, by OS number selection.

²⁾ Set to 0s. when DBI function is enabled using the DIP-switches on the front, at the bottom left corner (Fig 4-5).

³⁾ Set to 0s. when "no post-purge" feature is enabled using the DIP-switches on the front, at the bottom left corner (Fig 4-5).

Sequence at flame failure: immediate lock out

Table 3: Contact ratings

Terminal	Load	Contact rating
3	Blower / Fan	3A @ cosφ=0.6
4	Ignition transformer	3A @ cosφ=0.6
5	Intermittent pilot or main (DBI) valves	3A @ cosφ=0.6
6	Interrupted pilot	3A @ cosφ=0.6
7	Main (PI) valves	3A @ cosφ=0.6
12	Main (PI) valve 2 (ENH/ULT models only)	3A @ cosφ=0.6
8, 9, 10, 11	Control motor	0.5A @ cosφ=0.6
21	Alarm	0.5A @ cosφ=0.6

Total load (based on set): Max 8A (Internal Fuse : 10A)

Total load (based on terminal 4,5,6,7): Max 5A (Internal Fuse : 6.3A)

Table 4: Flame detection systems

Detector type	Flame detector model no.	Max. lead wire lengths	Standard stable flame current on jack plug
UV detector	C7027A, C7035A, C7044A	< 100m	4 μ A (min) 14 μ A (max)
Flame rod	Flame rod or rectifying optical sensors, C7012A,G (UV) or IRD1020.1 (IR)	< 15m	14 μ A (min)* 4 μ A (max)*

* When using a flame rod, the current on the flame jack plug is inverted. See also Fig 4-2.

ULTRAVIOLET (C7027/C7035/C7044)

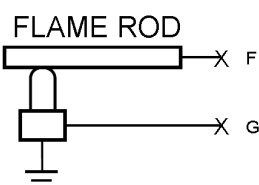

Flame detector leads are colour coded. The blue lead wire must be connected to the F terminal (T23) and the white lead wire to the G terminal (T24). The UV sensing tube is polarity sensitive. Reversing the lead wires even momentarily will destroy the UV sensing tube.

ULTRAVIOLET C7012A/G

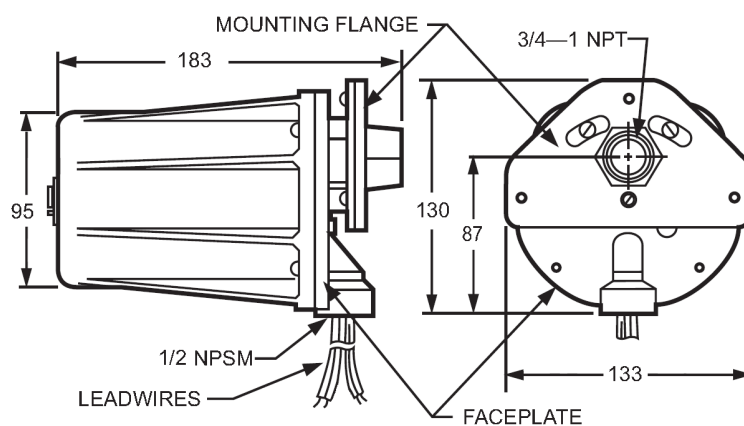

Mains input: Supply voltage

220 to 240Vac -15% +10% 50/60Hz or
110 to 120Vac -15% +10% 50/60Hz

Allowable ambient Temperature & Humidity

-10 °C; +60°C

90% RH max. at 40°C (non-condensing)

Classification to EN298 (Chapter 4)

F/B/L/L/X/N

Where:

F = Fan assisted

B = Interrupted and Intermittent pilot capable

L (1st) = non-volatile lockout after flame loss

L (2nd) = non-volatile lockout after flame loss final stage

X = Fixed timings per model number

N = Intermittent operation (non-self-check)

Approvals

CE certification to EN298:2003 (gas, UV & flame rod)

CE certification to EN230:2005 (oil, UV only)

EN746-2 compliant

AGA certified

GOST-R listed

Power consumption

9VA

Protection class

IP40

Mounting

Plug-in mounting method using sub-base

Dimensions

103mm x 103mm x 124mm (W x D x H) incl. sub base

Status indicator LEDs

- Standby

- Purge

- Ignition

- Pilot

- Main

- Modulate

- Flame On

- Alarm

The LEDs will shortly blink as soon as power is applied to the DBC2000 and then as soon as there is a heat demand, indicate the burner sequence.

The LEDs are also used to indicate faults. For example, if a loss of flame signal occurs during RUN, the LEDs for Alarm, Flame and Main will blink the fault code.

Jack plug

The flame signal can be measured using the jack plug (Ø 3.5mm) on the front, using a microampere meter. The measuring device must be capable of reading microamperes between 2 and 15~20 µA.



CAUTION

Although the voltage on the jack plug is of low voltage, it is not considered to be safe when touching the wires connected to the jack plug, in case of a malfunction of the device. Therefore avoid touching the lead wires to avoid an electrical shock.

Reset switch

When the DBC2000 is in Lockout condition* press the internal or remote reset button one time to reset the DBC2000 and stop the alarm. The reset button must be held for a minimum of 3 seconds.

If the heat demand is still present, the DBC2000 will perform the start sequence normally when the fault condition has been resolved. Otherwise the lockout will repeat.

If during the lockout condition the DBC2000 is de-energized and power is reapplied afterwards, the DBC2000 will remain in lock out (non-volatile lock out).

A remote reset push button switch can be connected between terminals 15 and 19 (Standard Model) or between terminals 15 and 18 (Enhanced and Ultimate Models). The functionality of the remote reset is the same as the red push button on the front of the device, with one exception; the remote reset may occur only 5 times during 15 minutes of operation, whilst the internal reset button is unlimited.

* Remark:

Lockout condition refers to the state the DBC2000 is in after a safety shut-down occurs and the lockout timing (20 Seconds), plus the post purge timing (15 Seconds - if enabled) have been completed. For safety reasons the reset button is disabled immediately after a safety shut-down until both of these above timings are completed.

The lockout timing is fixed at 20 seconds for all models, to allow time for the air dampers to return to the start position, and to allow a safety time between ignition attempts, for applications without pre- and post-purge.

Note: The Alarm and LED's will indicate the fault immediately, but cannot be reset until the unit has progressed to the Lockout Condition.

Remote communication

- Under construction

4. DIMENSIONS

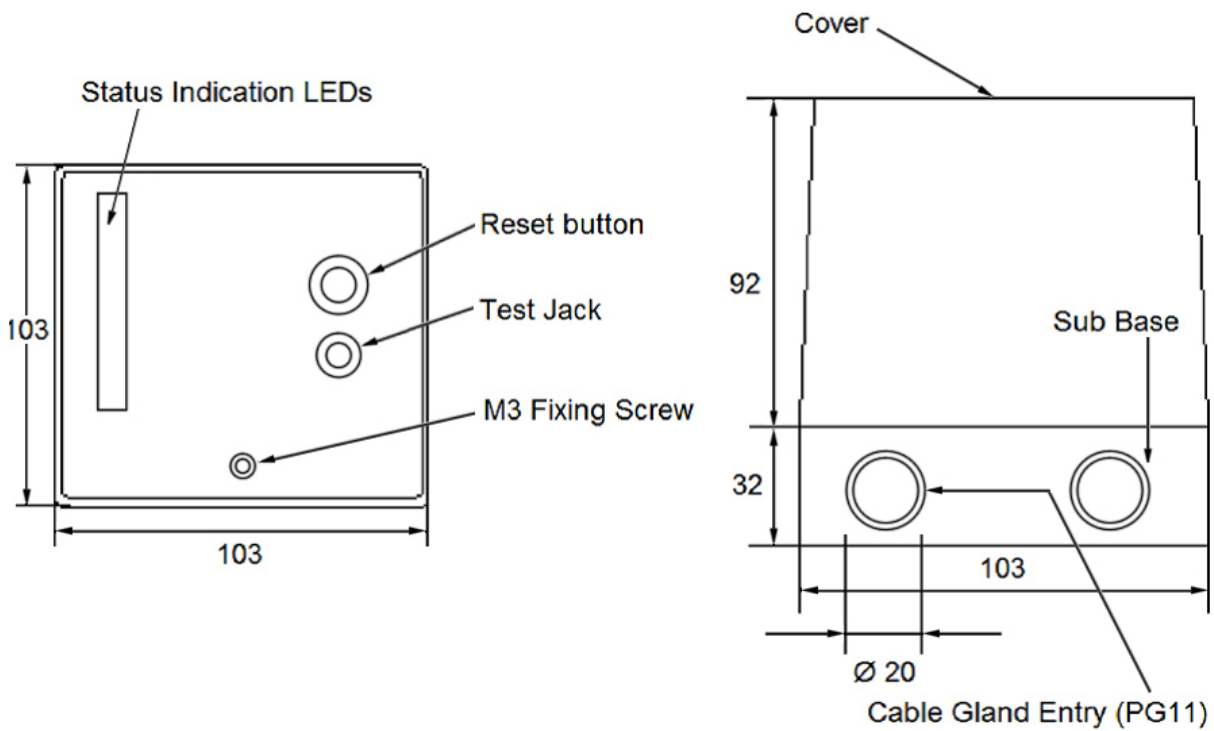

Fig. 1: External Dimensions (in mm)

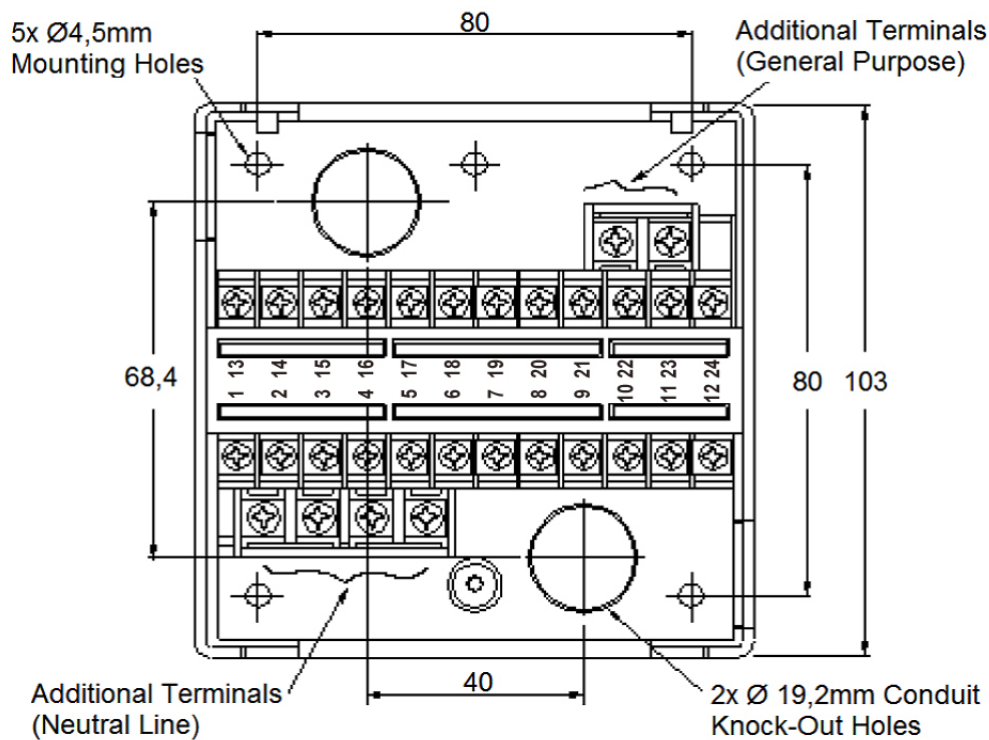

Fig. 2: Mounting dimensions of sub-base and terminal layout

5. INSTALLATION AND WIRING

CAUTION

INSTALLATION

When Installing this Product...

1. Read these instructions carefully. Failure to follow them could damage the product or cause a hazardous condition.
2. Check the ratings given in the instructions and marked on the product to make sure the product is suitable for the application.
3. Installer must be a trained, experienced, flame safeguard service technician.
4. After installation is completed, check out the product operation as provided in these instructions.



WARNING

Fire or Explosion Hazard.

Can cause property damage, severe injury, or death.

Carefully follow safety requirements when installing a burner control.



CAUTION

Electrical Shock Hazard or Equipment/Control Damage.

Disconnect power supply before beginning installation, to avoid electrical shock or equipment damage..

IMPORTANT

1. Wiring connections for the relay modules are unique; refer to Fig. 3-2 or the appropriate Specifications for individual subbase wiring.
2. Wiring must comply with all applicable codes, ordinances and regulations.
3. Wiring must comply with NEC Class 1 (Line Voltage) wiring.
4. Loads connected to the DBC2000E must not exceed those listed on the relay module label or the Specifications; see Table 3.
5. Limits and interlocks must be rated to simultaneously carry and break current to the ignition transformer and fuel valve(s).
6. All external timers must be listed or component recognized by authorities who have proper jurisdiction.

7. For on-off gas-fired systems, some authorities who have jurisdiction prohibit the wiring of any limit or operating contacts in series between the flame safeguard control and the main fuel valve(s).
8. Two UV flame detectors can be connected in parallel.
9. This equipment generates, uses and can radiate radio frequency energy and, if not installed and used in accordance with the instructions, can cause interference with radio communications. It has been tested and found to comply with the limits for a Class B computing device of Part 15 of FCC rules, which are designed to provide reasonable protection against such interference when operated in an industrial or commercial environment. Operation of this equipment in a residential area can cause interference, in which case, the users, at their own expense, may be required to take whatever measures are required to correct this interference.
10. This digital apparatus complies with the requirements as stated in the EN298 standard.
11. Do not install the Burner Controller under any circumstances in the following locations.
 - ① Where chemicals or corrosive gases are present, such as ammonia, sulfur, chlorine, ethylene compounds, acids, etc.
 - ② Install the relay module where the relative humidity never reaches the saturation point. The relay module is designed to operate in a maximum 85% relative humidity continuous, noncondensing, moisture environment. Condensing moisture can cause a safety shutdown or damage the device.
 - ③ Where temperatures exceed the maximum specification for this device.
 - ④ Where excessive continuous vibration exists.
12. Do not bundle power wiring and high voltage ignition cable with the flame detector wiring, or run them in parallel within the same conduit. High voltage cables must be kept separated at least 10 cm from the Burner Controller.
13. Use proper grounding work in accordance with the engineering standards for electrical equipment
14. Connect the high voltage cable of the ignition transformer properly to the ignition electrode. A poor connection can cause an electrical shock or damage the equipment. Additionally the ignition transformer must be properly grounded according to the standards.

REMOVE THE RELAY MODULE FROM ITS SUB BASE AND FIX THE SUB BASE

1. Loosen the M3 fixing screw as shown in Fig. 1 by about eight turns using a Philips head screwdriver.
2. Take the subbase and cover with both hands and unfold them gently. Fold the relay module upwards, the turning point is on the top. Do not apply excessive force, otherwise damage may occur.
3. Punch out the needed conduit knockout holes for the wiring as shown in Figs 1 and 2, and install the wiring conduit(s).
4. Using the fixing screws, mount the subbase in the specified position.

! Avoid to overtighten the fixation screw on the front of the device, to avoid damaging the (Phillips) head of the screw.

WIRING THE RELAY MODULE BOTTOM TERMINALS

1. For applications with a UV detector, remove the jumper terminal located at the terminal block on the bottom of the relay module.
2. For applications using remote communication, connect communication cable to "BUS" terminal located at the terminal block on the bottom of the relay module. In addition, set the communication address using the rotary switches at the bottom of the relay module.

WIRING THE SUB BASE

1. Fig. 2 shows the layout of the terminals on the subbase, and Figs. 3-1 to 3-3 show examples of connections to external equipment. Regarding the wiring to the flame detector, refer to Fig. 4.
2. When using Intermittent Pilot, connect the pilot valve to Terminal 5. Connect the main valves to Terminal 7 (Enhanced and Ultimate models: connect main valve 1 to Terminal 7 and main valve 2 to Terminal 12 for the VPS function)

3. When using Interrupted Pilot, connect the pilot valve to Terminal 6. Connect the main valves to Terminal 7 (Enhanced and Ultimate models: connect main valve 1 to Terminal 7 and main valve 2 to Terminal 12 for the VPS function)
4. When using direct ignition (DBI), jumper Terminals 15 and 22. And connect the Main(DBI) valves to Terminal 5.
5. When not using purge position interlock, jumper Terminals 15 and 16.
6. When not using start position interlock, jumper Terminals 13 and 17.
7. When not purge and start position interlocks, jumper Terminals 15 and 16 as well as Terminals 13 and 17 simultaneously.
8. Connect the safety switch circuit (lockout interlocks) between Terminals 15 and 18. The safety switch circuit must be closed always, otherwise a lockout occurs immediately.
9. For non-floating mains power grids (Neutral to Ground), connect the Line-L to Terminal 1 and the Line-N to Terminal 2. Use a correct fuse: 10A fast blow maximum.
10. Check all wiring circuits and assure that the correct fuse is installed. Check the correct voltage.
11. Finally plug the relay module on to its sub base and fix it with the M3 fixing screw. Do not overtighten the screw.
12. When using a surge absorber, connect it between Terminal 2 and application ground.
13. Connect the mains supply voltage using 0.75mm² or larger lead wire.
14. Never connect blank stripped wires to the wiring sub base. Loose wire strands may cause short circuits to electrically safe contacts which may cause an electrical shock hazard.

! Always use cable lugs to attach the wires to the sub base.

See Fig 2-1 for do's and don'ts about wiring.

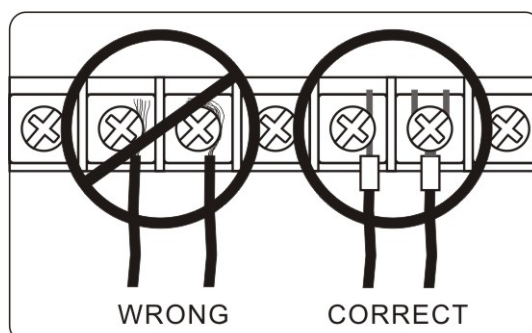

Fig. 2-1: Wiring the sub base terminals

DBC2000E standard model terminals	DBC2000E enhanced and ultimate model terminals
1 Line Voltage (L)	1 Line Voltage (L)
2 Line Voltage (N)	2 Line Voltage (N)
3 Blower / Fan (O)	3 Blower / Fan (O)
4 Ignition Transformer (O)	4 Ignition Transformer (O)
5 Intermittent Pilot or Main (DBI) Valves (O)	5 Intermittent Pilot or Main (DBI) Valves (O)
6 Interrupted Pilot (O)	6 Interrupted Pilot (O)
7 Main (PI) Valves (O)	7 Main (PI) Valve 1 (O)
8 Firing Rate common (I)	8 Firing Rate common (I)
9 Firing Rate Modulate (O)	9 Firing Rate Modulate (O)
10 Firing Rate Purge (O)	10 Firing Rate Purge (O)
11 Firing Rate Start (O)	11 Firing Rate Start (O)
12 Post-purge Select (I)	12 Main (PI) Valve 2 (O)
13 Low Fire Rate Feedback Override (I)	13 Low Fire Feedback Override (I)
14 Air Flow Switch (I)	14 Air Flow Switch (I)
15 Control Switches Common (O)	15 Control Switches Common (O)
16 HF - Purge Position Interlock (I)	16 HF - Purge Position Interlock (I)
17 LF - Start Position Interlock (I)	17 LF - Start Position Interlock (I)
18 Safety Limits (I)	18 Remote Reset (I)
19 Remote Reset (I)	19 Safety Limits (I)
20 Heat Demand (I)	20 Heat Demand (I)
21 Alarm (O)	21 Alarm (O)
22 PI/DBI select (I)	22 VPS Pressure Switch (I)
23 Flame Detector (F)	23 Flame Detector (F)
24 Ground (G)	24 Ground (G)

Note: terminals 18 and 19 are swapped for the Standard and Enhanced/Ultimate models. This is to prevent that a Standard model can be used by mistake in a system that is wired for an Enhanced or Ultimate model.

Fig. 3-1: Terminal layout

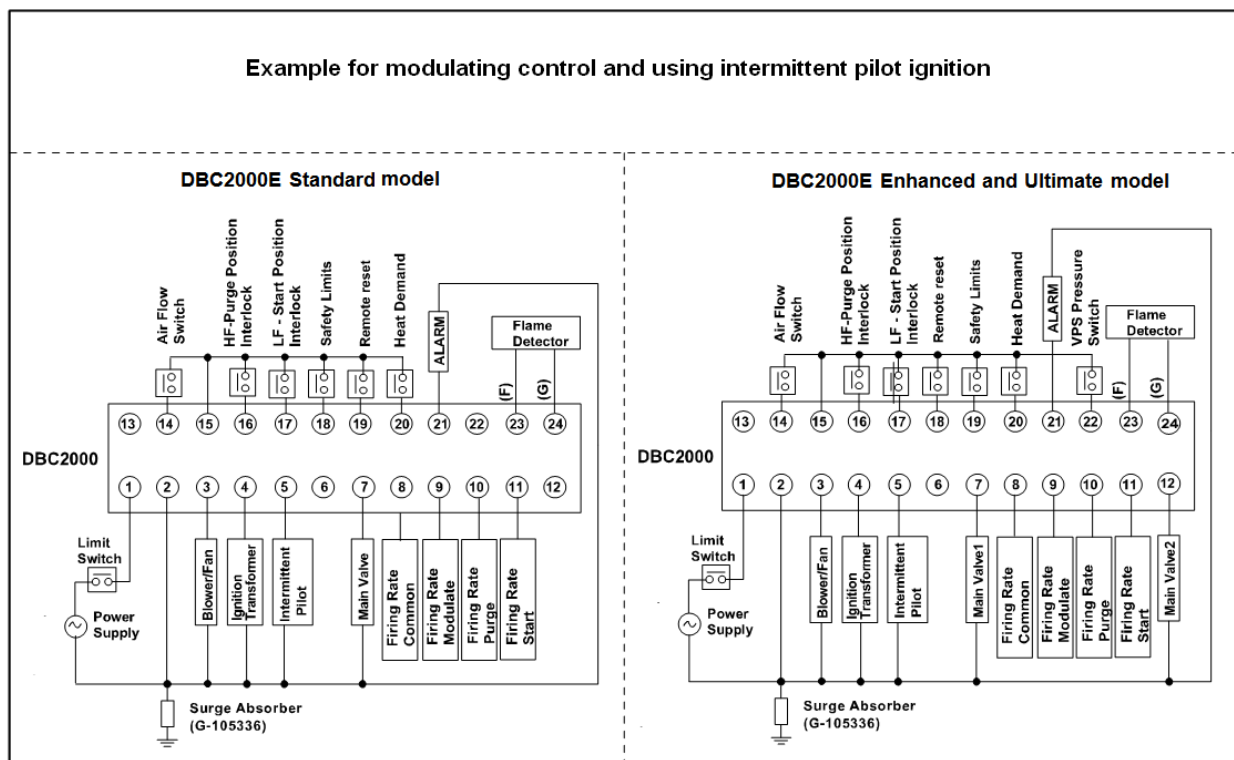

Fig. 3-2: Example of wiring to external equipment (see fig 3-3 for more)

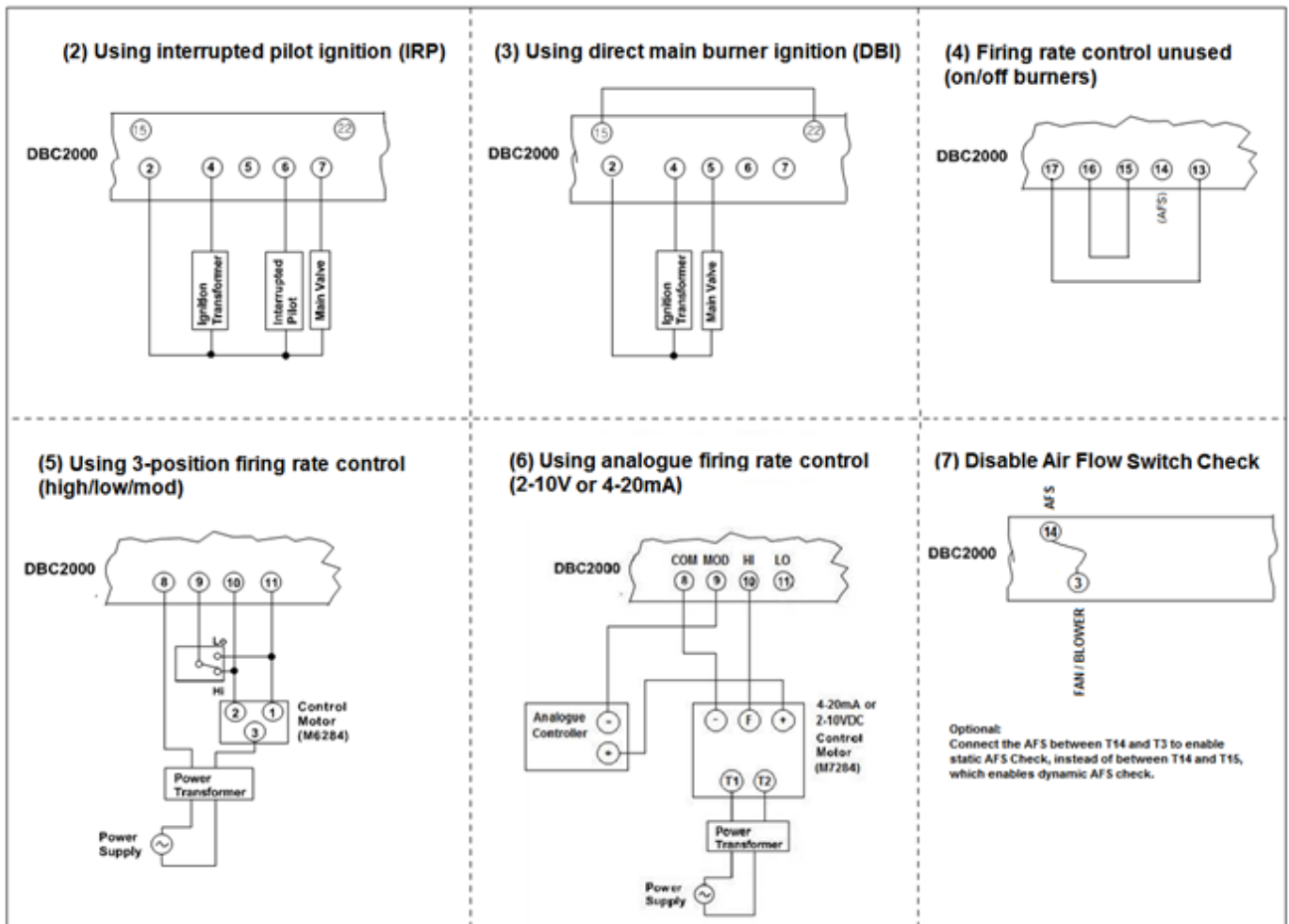

Fig. 3-3: More examples of wiring to external equipment

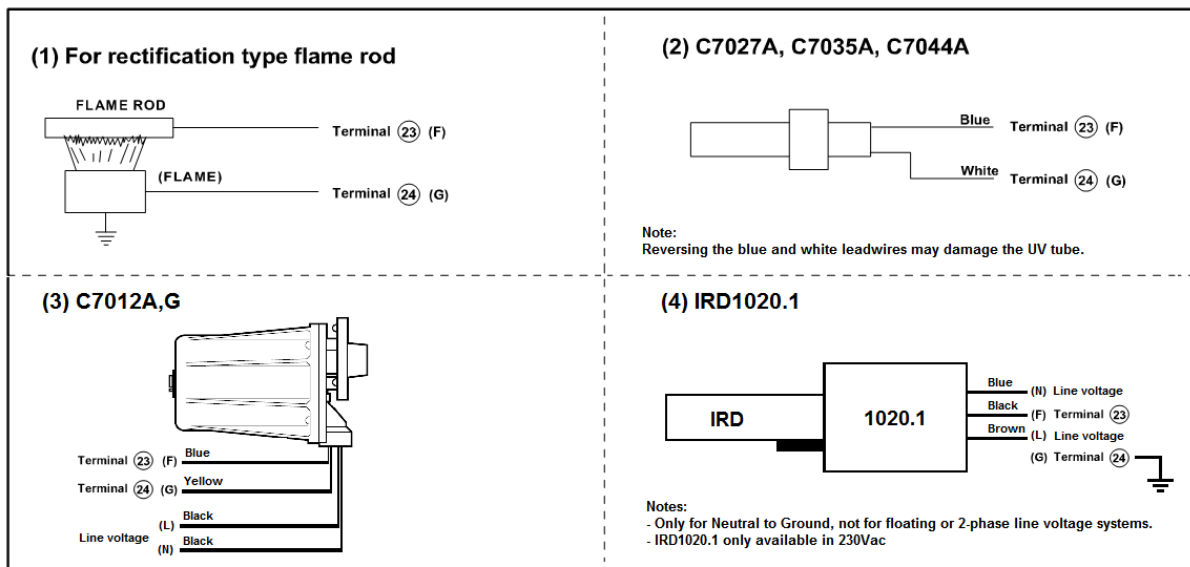

Fig. 4-1: Wiring a flame detector

⚠ CAUTION

There is line voltage on flame sensor inputs. Don't touch the lead wires of the UV detector or the flame sensing electrode to avoid an electrical shock.

Flame signal monitoring

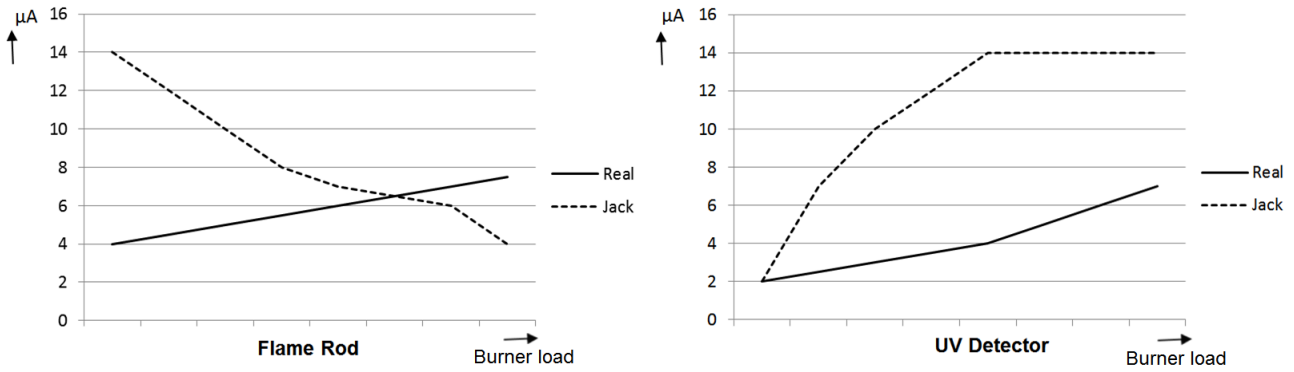

Fig. 4-2: Real flame current versus reading on frontal jack plug.

Note:

The flame signal strength on the flame current jack plug is only for reference and can vary between different DBC2000 devices.

When measuring the flame signal current directly in the flame sensor wiring whilst:

1. Using a flame rod, the (multi-)meter will show the real flame current in μA .
2. Using a UV sensor (C7027, C7035 or C7044), the current in the sensor lead wires will be in the range of 20...25mA (inverted values).

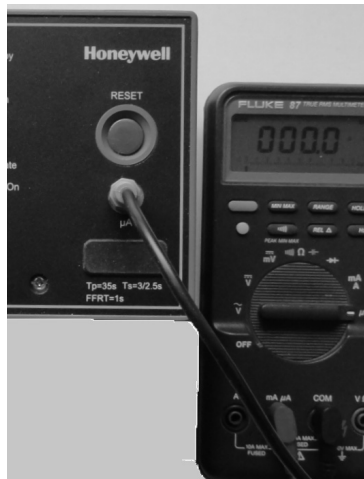

Fig. 4-3: Measuring flame signal with multi meter (μA range selection) using a jack plug.



STD & ENH Models (flame detector select only)



ULT Model (bus connector and address switches)

Fig. 4-4: Position of flame sensor selection jumpers and bus connector on the back of the DBC2000.

SETTING THE OPTIONAL FEATURES

1. Post-purge or no post-purge

Post-purge mode (default for all DBC2000E models): before going to standby after heat demand has ended, the DBC2000E performs a 15s post-purge cycle to ventilate the burner chamber, with the blower switched on and the firing rate in low position to save energy.

No post-purge mode (selectable option): the DBC2000E goes to standby with the blower switched off immediately after heat demand ends and the firing rate goes to low position.

STD model:

To enable no post-purge, apply line voltage to terminal 12 on the wiring base. Practically this means that a jumper is placed between terminals 1 (L) and 12.

ENH/ULT models:

To enable no-post-purge, make the correct DIP-switch setting on the front of the DBC2000E. SW1 = POSTPURGE select. Factory set to post-purge (SW1=off). See fig. 4-5 to locate the DIP switches.

2. Pilot Ignition (PI) or Direct main Burner Ignition (DBI)

PI mode (default): the main burner is ignited indirectly by using an interrupted or intermittent pilot flame. After the pilot is ignited and stabilized, the DBC2000E goes for a second trial of ignition (2nd safety and main stabilization are 3s) to ignite the main burner.

DBI mode (selectable option): the intermittent pilot ignition cycle is used to ignite the main burner directly via the spark igniter. The second trial for ignition has become redundant in this mode. In DBI mode the 2nd safety and main stabilization times are 0s and DBC2000E goes straight into running/modulate after pilot stabilization.

STD model:

To enable DBI mode, apply line voltage to terminal 22 on the wiring base. Practically this means that a jumper is placed between terminals 1 (L) and 22.

ENH/ULT models:

To enable DBI mode, make the correct DIP-switch setting on the front of the DBC2000E. SW2 = DBI/PI select. Factory set to PI (SW2=off). See fig. 4-5 to locate the DIP switches.

3. Valve Proofing System – VPS (ENH/ULT models only)

Connect a gas pressure switch (such as the C6097A2210) to terminal 22 on the wiring base (N.O. contact).

Rule of thumb: adjust the pressure switch to 0.5x the inlet pressure.

Table 5: VPS function:

VPS enabled SW3 = on	VPS is being performed
VPS disabled SW3 = off	VPS is not used (default)
VPS pre-config SW4 = on SW5 = off	The VPS test cycle is performed during pre-purge cycle, right after the heat demand has started.
VPS post-config SW4 = off SW5 = on	The VPS test cycle is performed right after the heat demand has ended.
VPS both config SW4 = on SW5 = on	The VPS test cycle is performed before <u>and</u> after the heat demand cycle.

Table 6: VPS timing:

VPS test time 25s	SW6=on SW7=on
VPS test time 20s	SW6=on SW7=off
VPS test time 15s	SW6=off SW7=on
VPS test time 10s (default)	SW6=off SW7=off

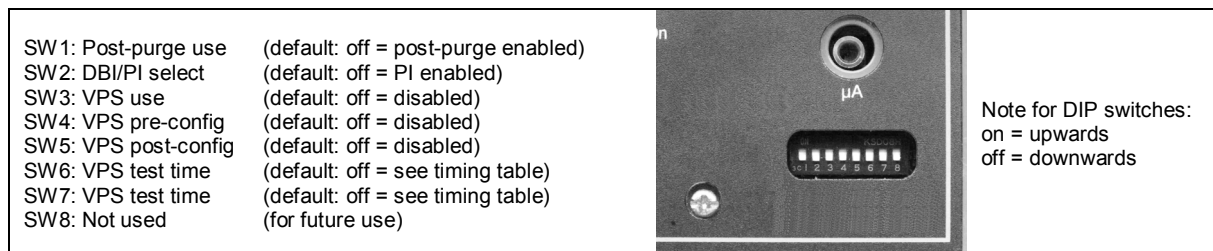

Fig 4-5 Configuration DIP switches (VPS) on the front of the DBC2000E (ENH/ULT only)

6. OPERATION

NORMAL OPERATION

Table 7: Normal operation sequence

Inputs	Operation of DBC2000 and device	Indicator LED *
HEAT DEMAND SW OFF AIR FLOW SW OFF SAFETY LIMIT SW ON	The power supply voltage is applied across Terminal 1 and 2. When no flame signal is present, the combustion airflow switch is opened (T14=OFF) and safety lockout circuit is closed (ON), it is possible to start.	●○○○○○○○
HEAT DEMAND SW ON START Pos SW ON PURGE Pos SW OFF	The blower is energized (T3). Firing rate goes to PURGE position. Air flow switch closes (T14=ON) as soon as air flow is present.	●●○○○○○
AIR FLOW SW ON START Pos SW OFF PURGE Pos SW ON	The pre-purge timer starts counting as soon as PURGE interlock is closed (T16=ON).	
PURGE Pos SW OFF	After the completion of pre-purge timing, firing rate goes to START position.	
	The ignition wait timer starts counting as soon as the START position interlock is closed (T17=ON).	
START Pos SW ON	After completion of the ignition wait timing, the Ignition sequence starts. The Ignition transformer is energized. The Intermittent and Interrupted pilot valve outputs are energized (T5 and T6).	●○●○○○○○ ●○●○○○●○
FLAME ON	When a flame is detected after the ignition trial has ended (Safety1), the pilot stabilization time starts.	●○○●○○●○
	After completion of the pilot-stabilization time, the Main valves are energized (T7=ON). Note: Enhanced Model: also (T12=ON). The Main trial for ignition takes place (Safety2).	●○○○●○○○
	After completion of the main trial time, Interrupted pilot valve is deenergized (T5=OFF). The Main stabilization time starts.	●○○○●○○○
PURGE & START Pos SW IGNORED	After completion of the main stabilization time, the firing rate goes to modulation position and releases control to an external modulation device.	●○○○○●●○
HEAT DEMAND SW OFF	The intermittent pilot valve and main valves are deenergized (T6=OFF and T7=OFF). Note: Enhanced Model: also (T12=OFF). Firing rate moves to PURGE position. The post-purge timing takes place.	●●○○○○○
FLAME OFF	After the completion of the postpurge time, the blower is deenergized and firing rate moves to START position.	●○○○○○○○
AIR FLOW SW OFF SAFETY LIMIT SW ON	After the air flow switch goes OFF, DBC2000E returns to the STANDBY condition, waiting for the next heat demand.	

* For LED indication, ○ means 'off', ● means 'illuminated'.

* The LEDs are arranged in the following order: Standby, Purge, Ignition, Pilot, Main, Modulate, Flame and Alarm at the left front side of the DBC2000.

Fig 5a. Normal operation: **POST-PURGE** configuration.

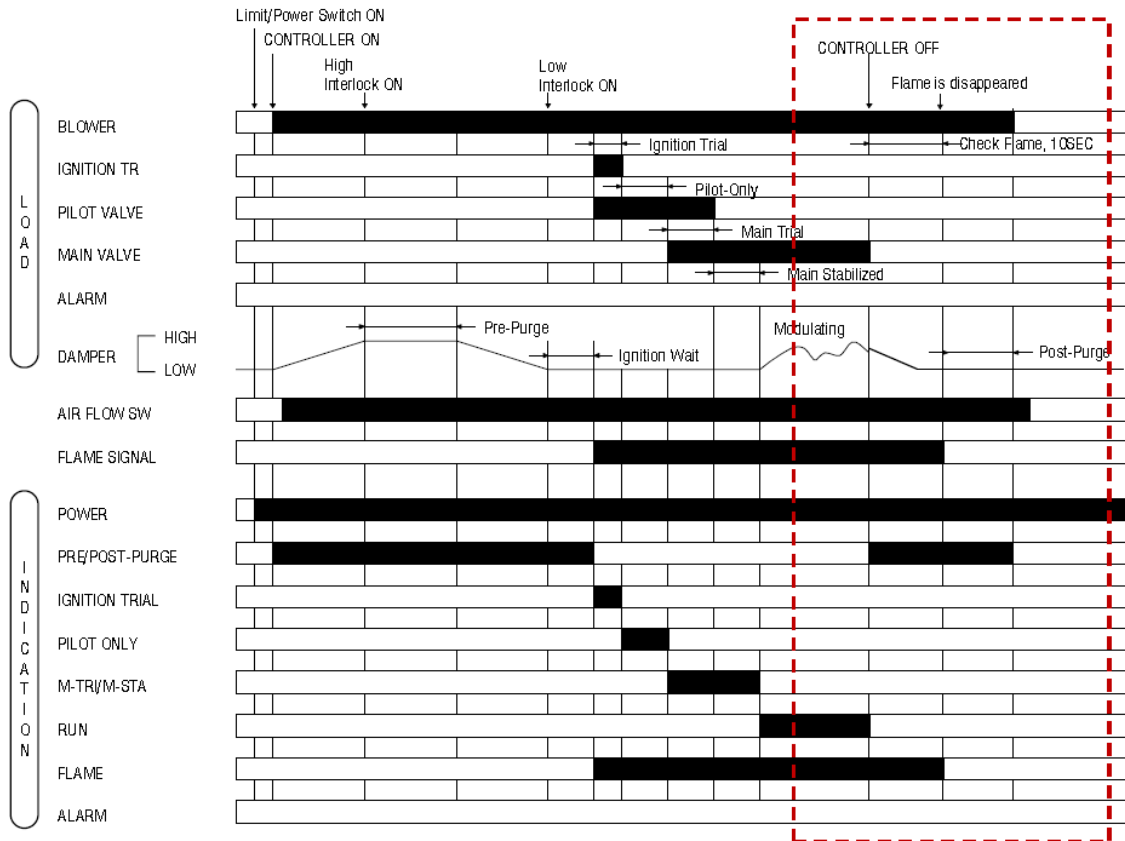
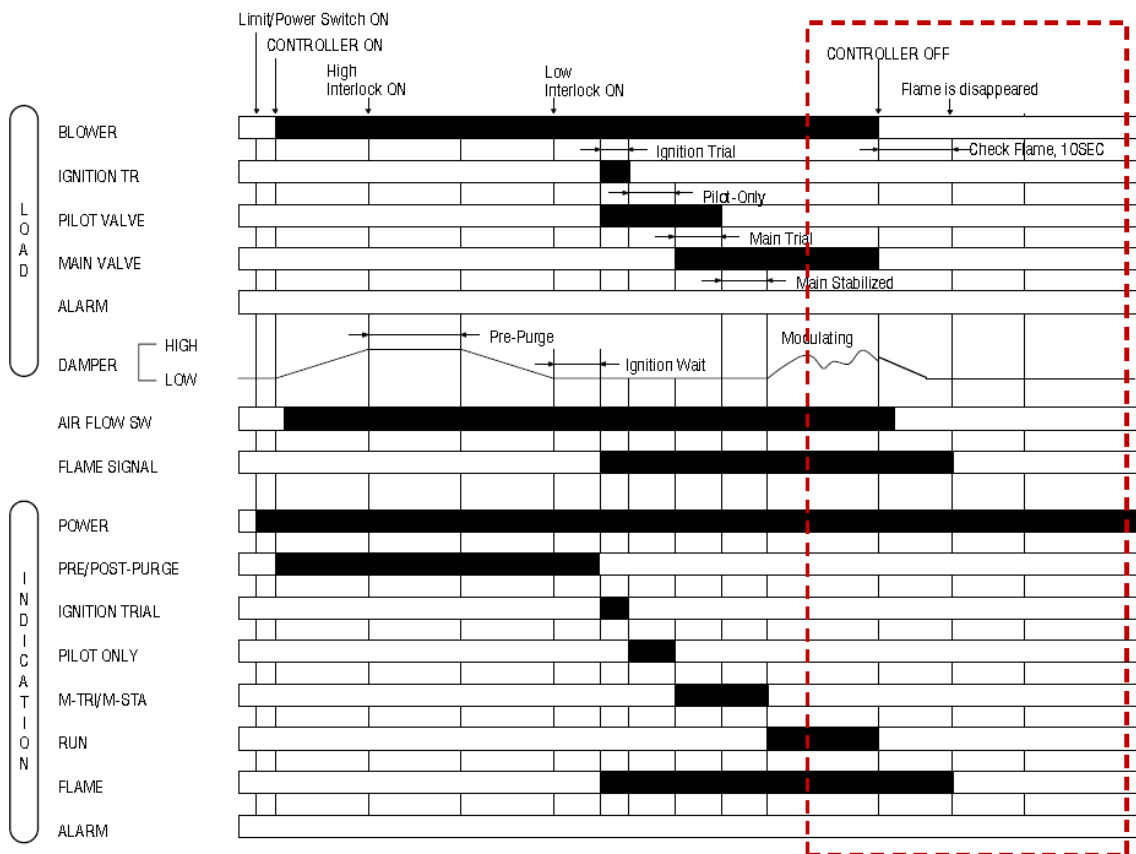

Fig 5b. Normal operation: **NO-POST-PURGE** configuration.



7. TROUBLE SHOOTING

ERROR TYPES AND SAFE SHUTDOWN

If a critical error related to safety operation (such as a loss of flame, opening of the air flow switch during the ignition trial and run sequence) is detected, the DBC2000 instantly goes into lock-out and goes to pre-purge status.

If a non critical error is detected (such as opening of the air flow switch during post-purge), DBC2000 holds the sequence during the lock-out time, allowing time for the error to rectify, and then goes into lock-out.

For all types of errors, the status LEDs indicate the status information to the operator.

Fig. 6 to Fig. 13 show the sequence of DBC2000 in case of some error. And Table 8 shows the status of LEDs for each error.

The product handbook (ENS7003) shows the different scenarios for possible failures.

Fig 6a. Failure to ignite the pilot: **POST-PURGE** configuration.

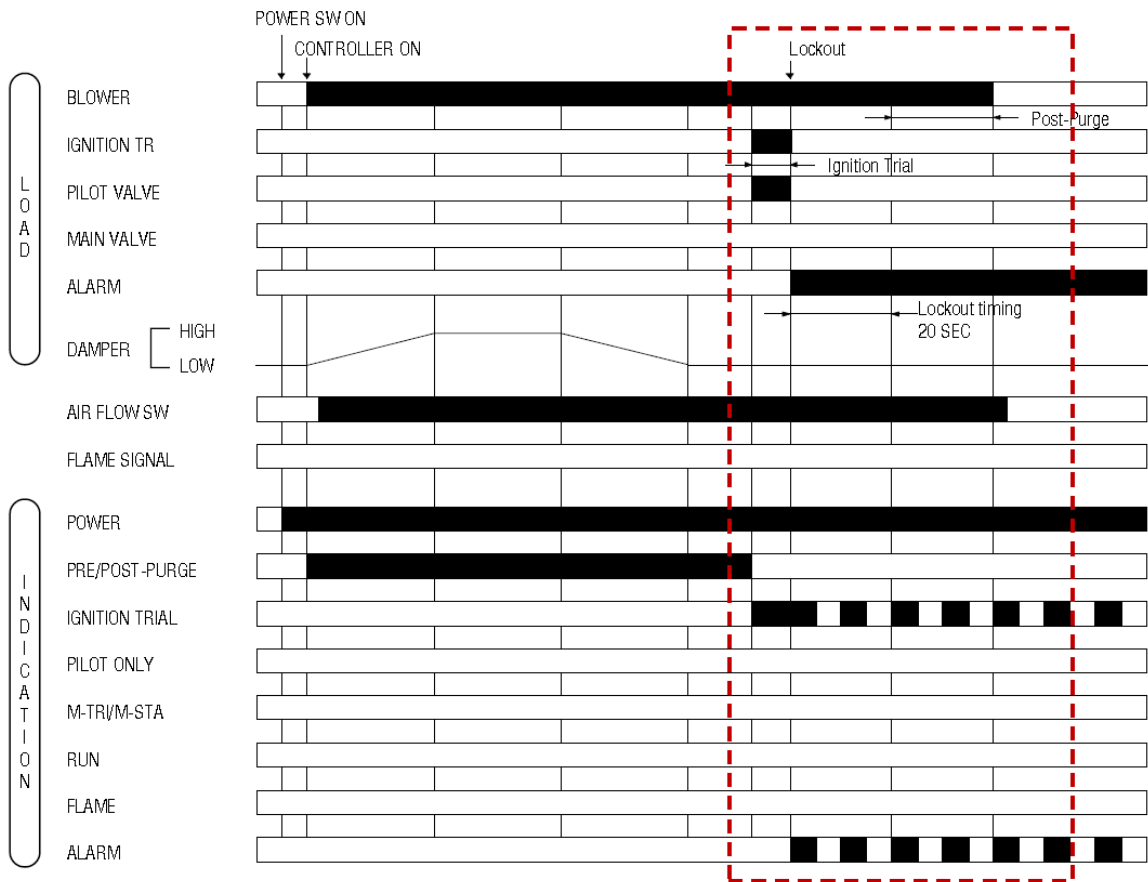

Fig 6b. Failure to ignite the pilot: **NO-POST-PURGE** configuration.

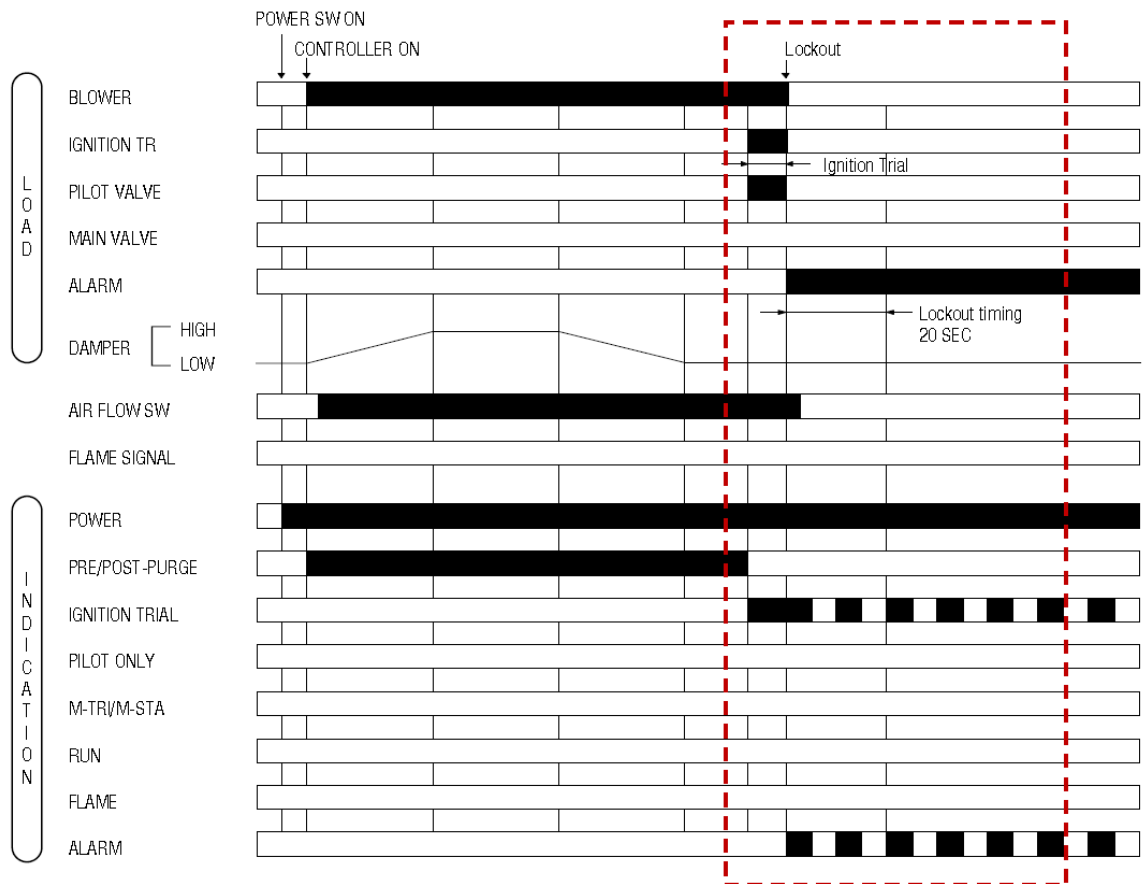

Fig 7a. Flame failure during run period: **POST-PURGE** configuration.

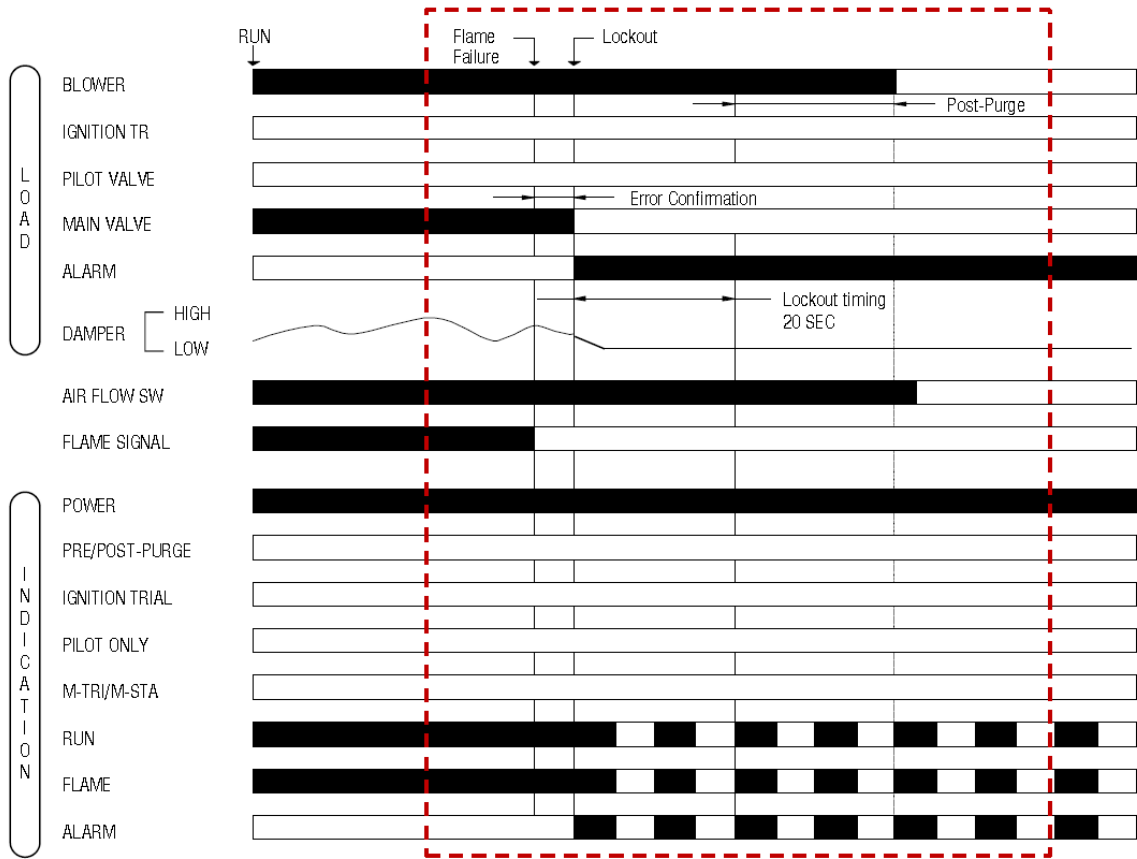

Fig 7b. Flame failure during run period: **NO-POST-PURGE** configuration.

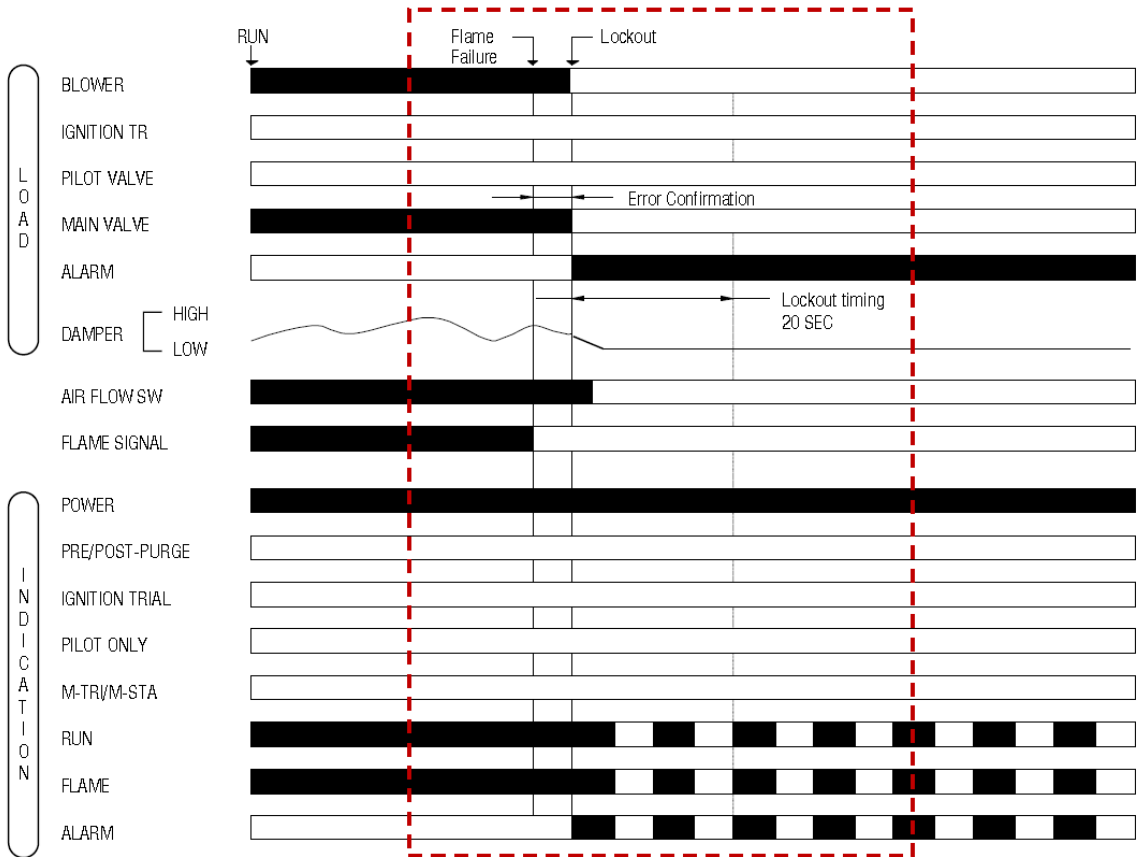

Fig 8. False flame is generated during standby.

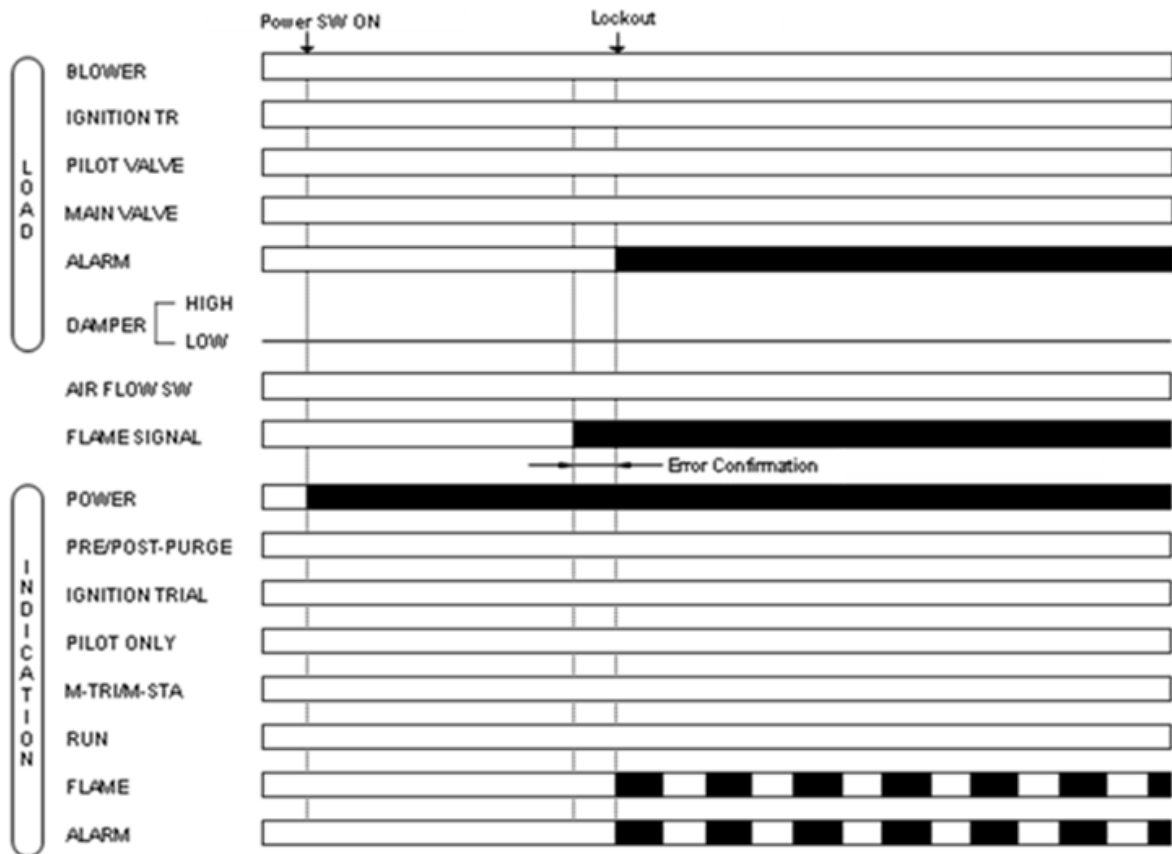

Fig 9a. False flame is generated during pre-purge: **POST-PURGE** configuration.

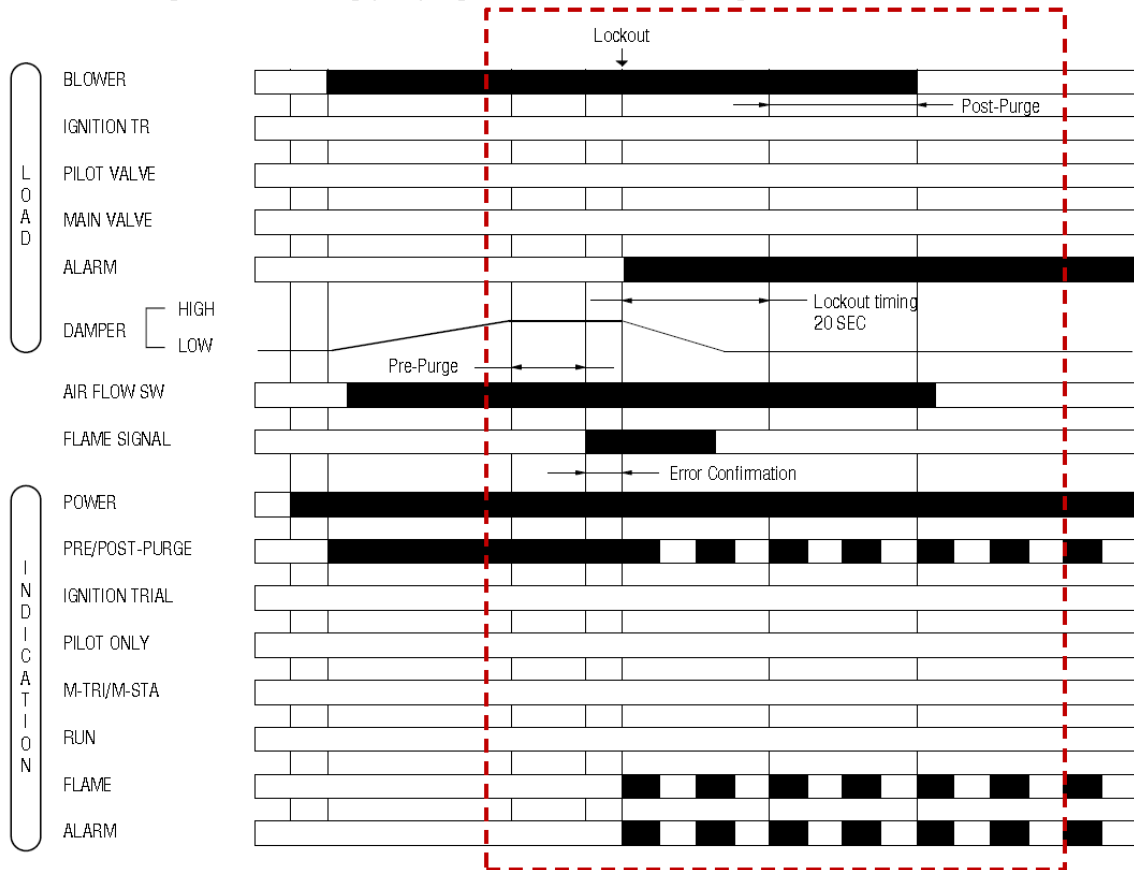

Fig 9b. False flame is generated during pre-purge: **NO-POST-PURGE** configuration.

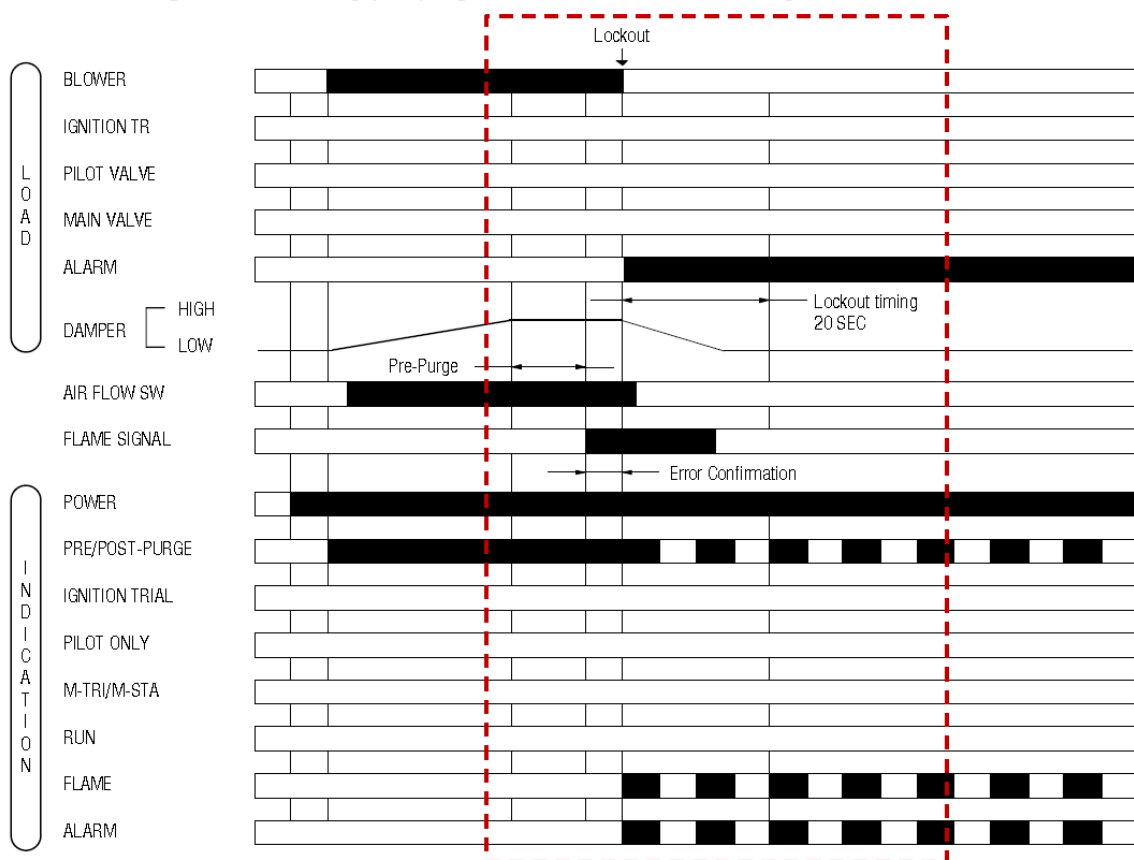

Fig 10. Air flow switch goes OFF during pre-purge and remains OFF after the Lockout timing.

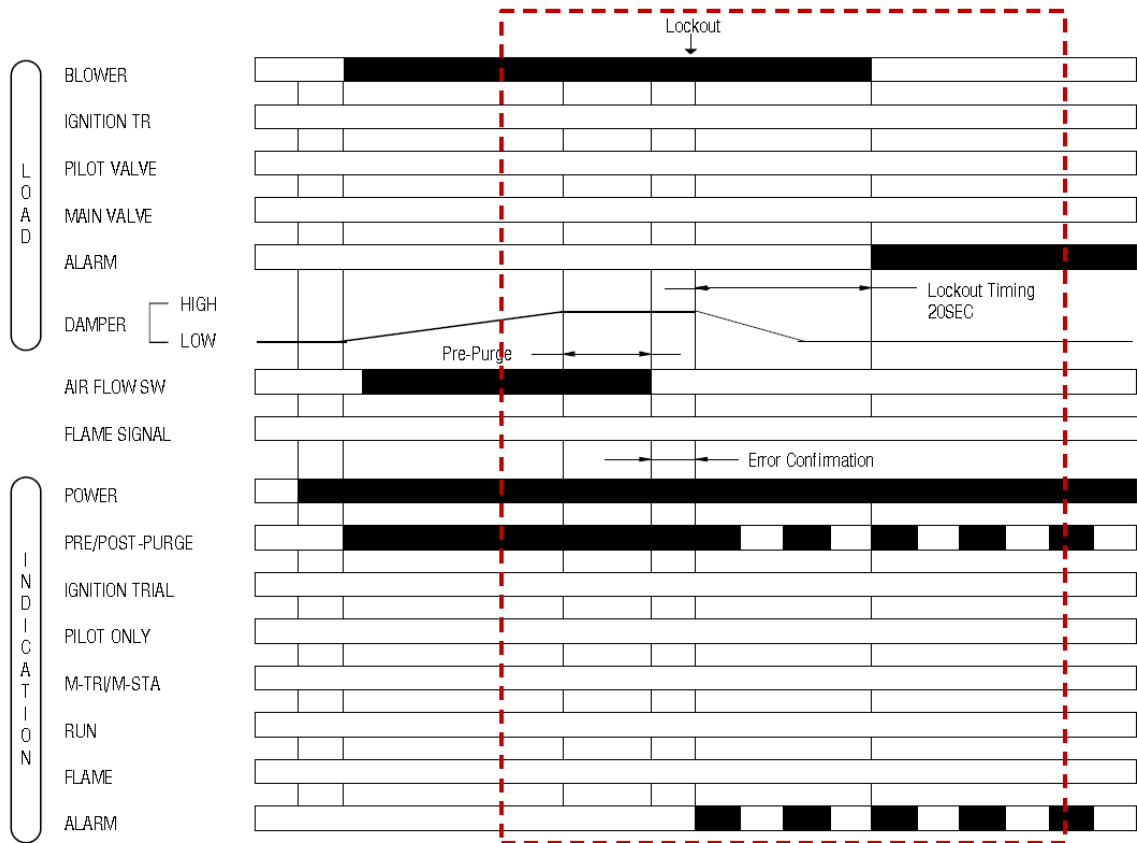

Fig 11. Air flow switch goes OFF during pre-purge and comes back ON before Lockout timing.

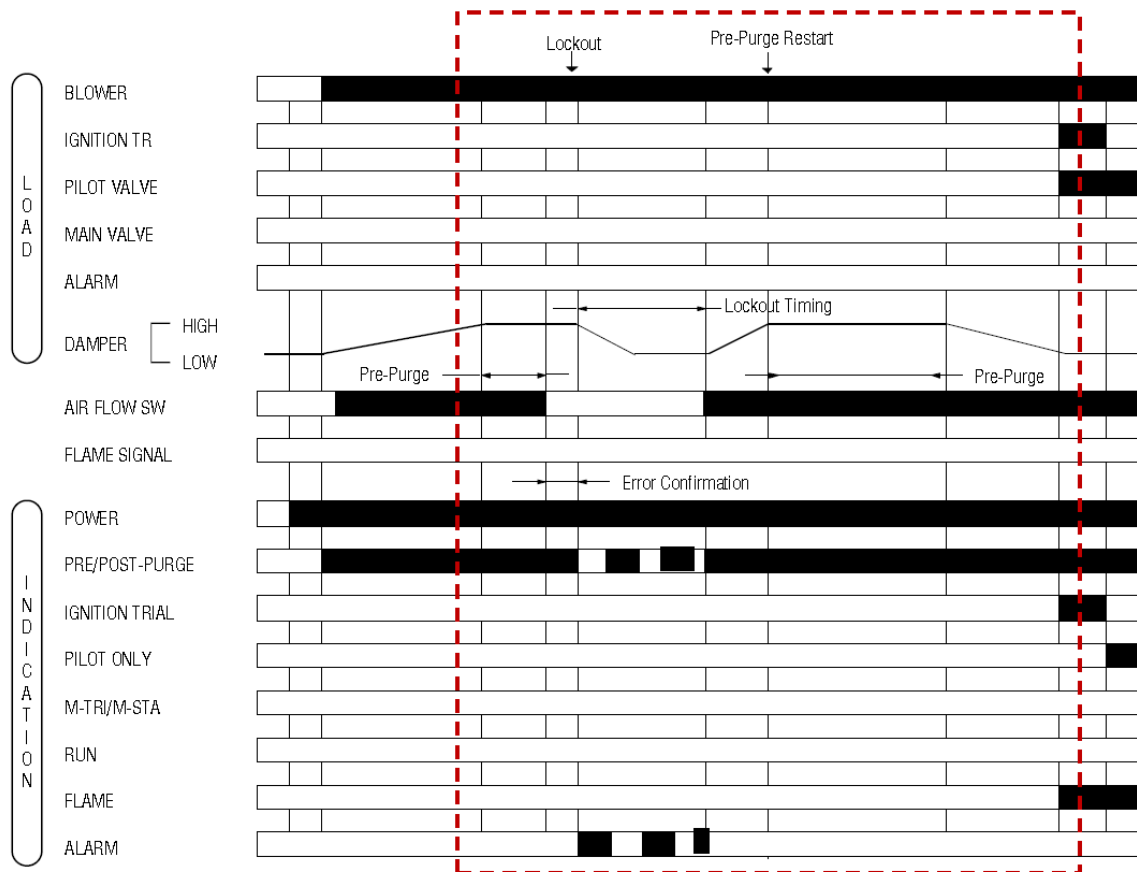

Fig 12a. Flame signal remains present after the end of heat demand: **POST-PURGE** configuration.

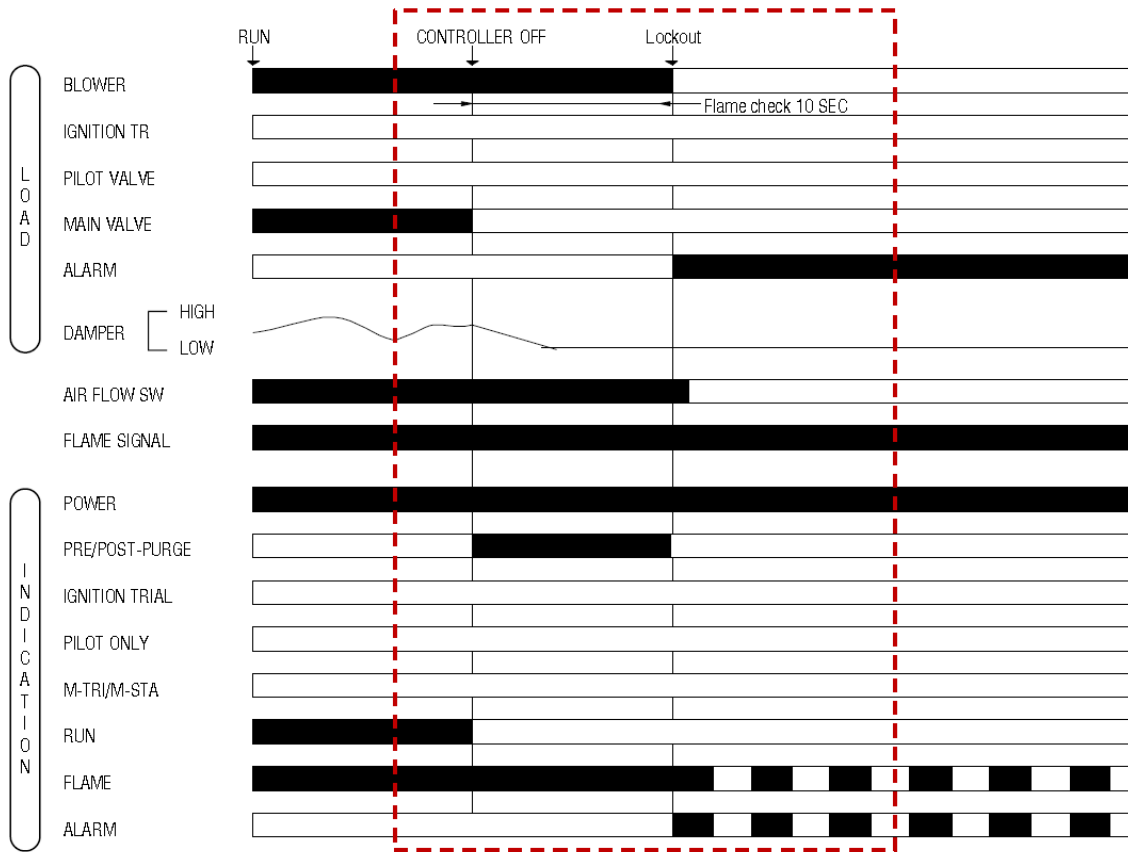

Fig 12b. Flame signal remains present after the end of heat demand: **NO-POST-PURGE** configuration.

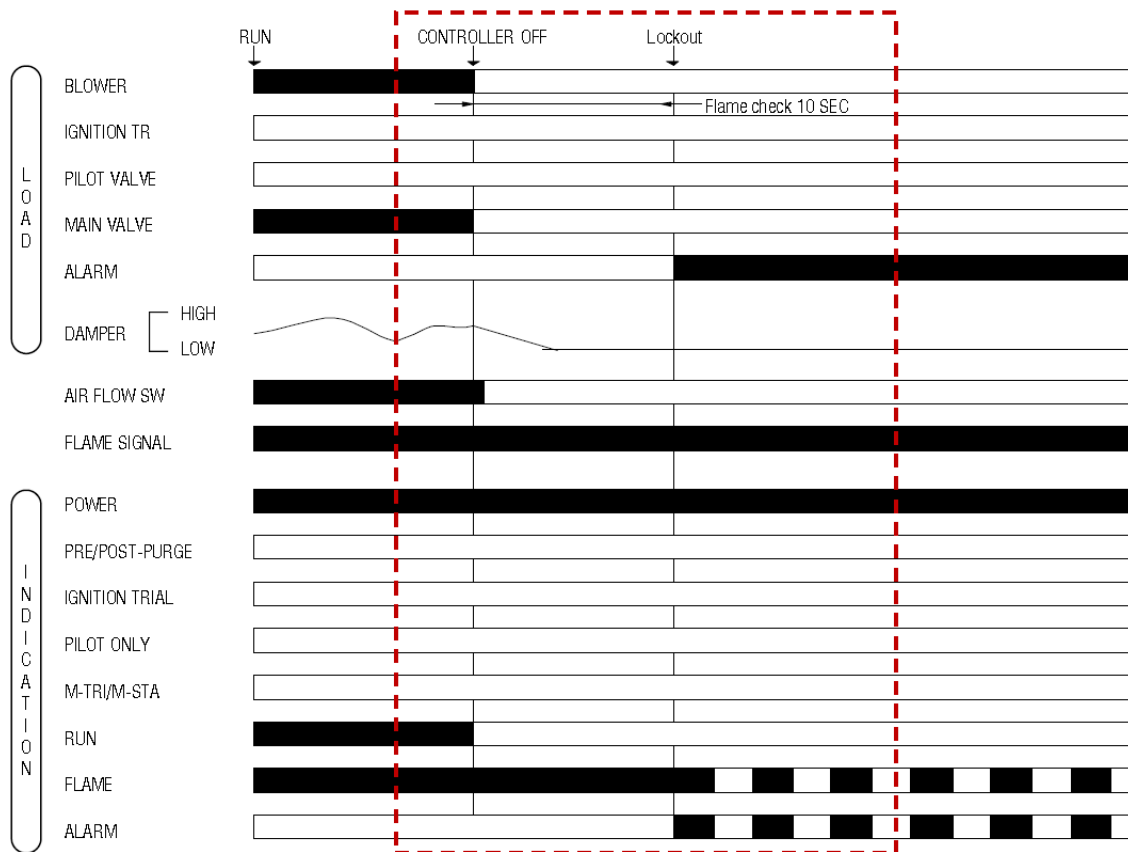

Fig 13a. Air flow switch opens (OFF) during Pilot stabilization: **POST-PURGE** configuration.

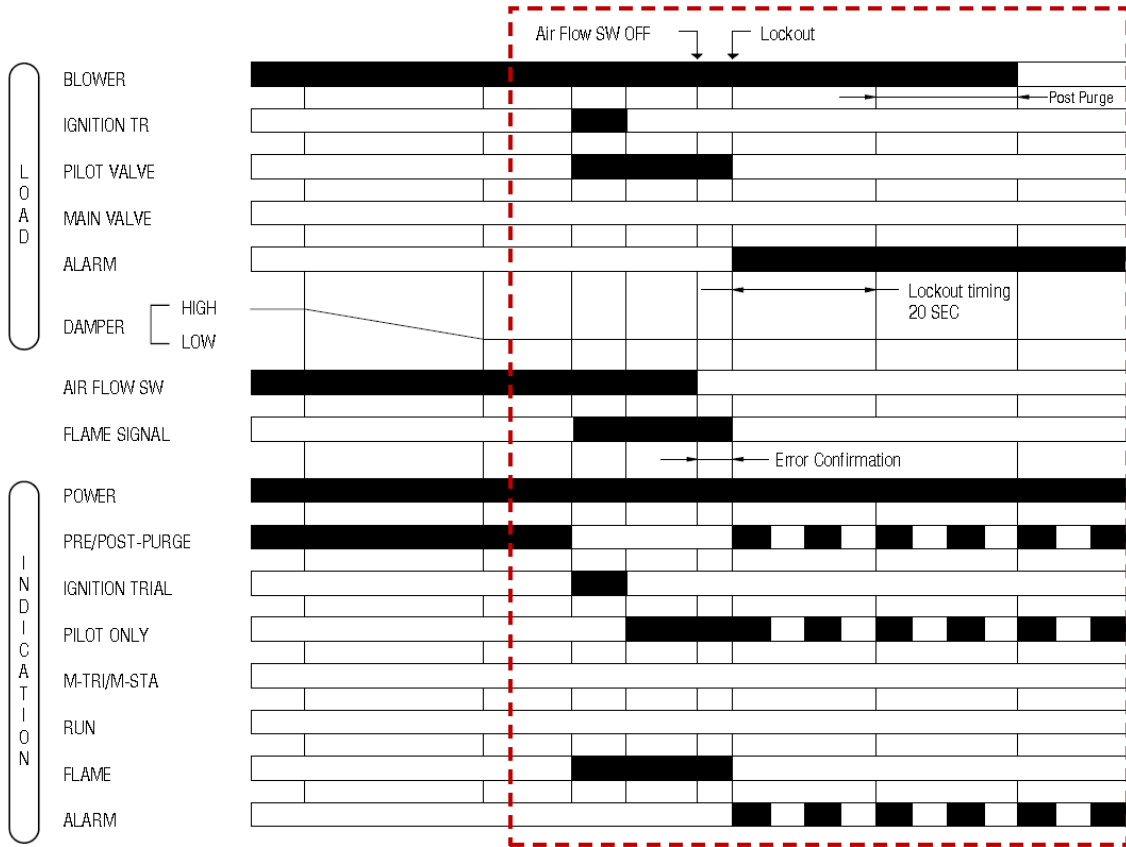

Fig 13b. Air flow switch opens (OFF) during Pilot stabilization: **NO-POST-PURGE** configuration.

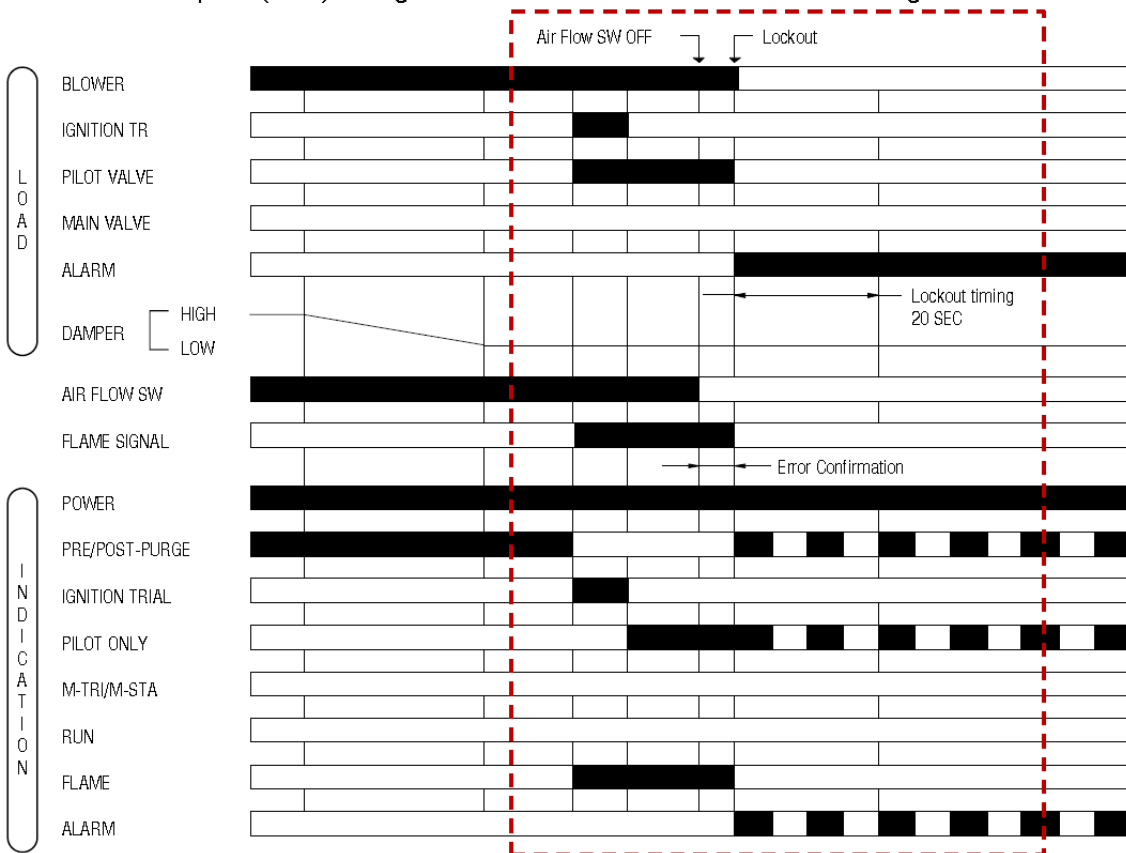

Table 8: Error condition and LED status

Sequence	Error condition	Indicator LED status (*1)
All	Safety limits opened at any time (no voltage present at T18 (STD model) or T19 (ENH/ULT model))	●○○○○○○●
Standby (*2)	Air flow switch remains ON (closed) for more than 5 minutes, or START position interlock switch remains OFF(opened) for more than 5 minutes.	●●○○○○○○●
	Flame signal is present	●○○○○○○●
	Blower motor is energized	●●●●○○○○●
Pre-purge	Air flow switch remains OFF for more than 5 minutes after the heat demand has started.	●●○○○○○○●
	PURGE position interlock switch remains OFF for more than 5 minutes after the heat demand started.	●●●○○○○○●
	Both PURGE and START position interlocks ON at the same time during prepurge period	●●●○○○○○●
	START position interlock remains OFF more than 5 minutes after pre-purge has finished	●●●○○○○○●
	Air flow switch goes ON within 5 minutes after the heat demand started, but air flow switch goes OFF again.	●●○○○○○○●
	Flame signal is present.	●●○○○○○○●
Ignition Standby	Air flow switch goes OFF	●●○○○○○○●
	Flame signal is present	●●○○○○○○●
Pilot Ignition	Air flow switch goes OFF	●●●○○○○○●
	Ignition failure (flame signal is not present after ignition-trial).	●○○○○○○●
Pilot only	Air flow switch goes OFF	●●●○○○○○●
	No flame signal	●○○○○○○●
Main ignition	Air flow switch goes OFF	●●○○○○○○●
	No flame signal	●○○○○○○●
Main ignition Stabilization	Air flow switch goes OFF	●●○○○○○○●
	No flame signal	●○○○○○○●
Run	Air flow switch goes OFF	●●○○○○○○●
	No flame signal	●○○○○○○●
Post-purge	No power is supplied to Terminal 3 because of internal relay contact failure.	●●●○○○○○●
	Flame signal is present for more than 10 seconds after heat demand has ended.	●○○○○○○●
	Air flow switch keeps ON more than 5 minutes after post-purge.	●●○○○○○○●
All	<ol style="list-style-type: none"> 1. Line voltage out of specs for more than 2 seconds 2. Line frequency out of range for more than 2 seconds 3. Excessive noise on power line or in the area 4. Internal device problem: CPU clock out of sync 	●○○○○○○●

*1 : For LED indication, ○ means 'off', ● means 'illuminated', ● means 'blinking'.

The LEDs are arranged in the following order: Standby, Purge, Ignition, Pilot, Main, Modulate, Flame and Alarm at the left front side of the DBC2000.

*2 : If an error occurs during Standby, the DBC2000 will not lock-out but LEDs indicate the current error status.

In this case, the DBC2000 cannot start before the error is resolved.

8. Approvals and Maintenance

Declaration of Conformity

Honeywell Technologies Sàrl
Z.A. La Pièce 16
1180 Rolle
Switzerland

declares under it's sole responsibility that the following product family of **burner controllers**:

DBC2000 E 1xxx / DBC2000 E 2xxx

to which this statement relates, is:

- in conformity with the essential requirements of the **Gas Appliance Directive 2009/142/EC**

based on EN 298

and in conformity with the type as described in the EC type-examination certificate issued by DVGW CERT GmbH in Bonn with pin number **0085CM0138**

- in conformity with the essential requirements of the **Low Voltage Directive 2006/95/EC**

based on EN 60730-2-5

- in conformity with the essential requirements of the **EMC Directive 2004/108/EC** on immunity

based on EN 298 immunity requirements

Conformity with the essential requirements of the **EMC Directive 2004/108/EC** on emission can only be determined in the application.

This product is under surveillance at KIWA Nederland BV.

Emmen, October 2011

Signed for and on behalf of Honeywell Technologies Sàrl,

A.Veld

Manager Standards & Approvals

Maintenance and service

The designed lifetime* of this product is 10 years, based on date code, or 1.000.000 cycles under normal conditions, according to:

a) the standard EN 298

b) the table on designed lifetime as stated on the Afecor website <http://www.afecor.org/>

We cannot assume that the product can be safely used beyond the mentioned designed lifetime. This lifetime is based on use of the control according manufacturer's instructions.

Regular inspection of the control by authorized personnel in accordance with guidelines of the appliance manufacturer is required.

After reaching the designed lifetime the product has to be replaced by authorized personnel.

Note: * Warranty as opposed to designed lifetime is described in the delivery terms.

APPENDIX: Calculations for VPS

General

The maximum allowable leak-rate (according EN676 and EN746-2) is 0,1% of the maximum burner capacity. The test time necessary to detect a failing valve is a function of:

- Inlet pressure
- Test volume
- Burner capacity

When the volume between two safety valves is bigger it takes more time (in case of a leaking valve) to change the status of the gas pressure switch (GPS).

The switching point of the GPS is set to 50% of the maximum inlet pressure. The test period T_p is calculated from the inlet pressure P_i , the test volume V_p (see Table a.) and maximum burner capacity Q_m . In a formula:

$$T_p = \frac{2 \times P_i \times V_p}{Q_m} \text{ [s]}$$

- P_i = inlet pressure [mbar]
 V_p = test volume, see also Table a [dm³]
 Q_m = burner capacity [dm³/h]
 T_p = test time [s]

Important

The total volume V_p has to be calculated with all volumes between the tested valves: internal volumes of valves and all pipes.

Calculation examples

Example 1

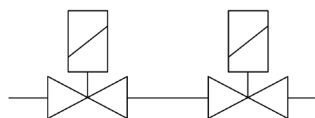

Calculation of the minimum test time (per valve) in a 2" threaded pipe train.

- P_i = 150 mbar
 Q_m = 60 dm³/h
 Gas valves used: 2" size with 0.5 meter pipe.
 To be calculated: T_p [s]

Calculation:

From Table a. :

$$2" \text{ @ } L=0.5\text{m} \rightarrow V_p = 2.3 \text{ dm}^3$$

$$T_p = \frac{2 \times 150 \times 2.3}{60} \text{ [s]}$$

Using the formula above, the minimum test time T_p = **11.5s**
 The DBC2000E2 must be set to 15s test time (see page 11).

Example 2

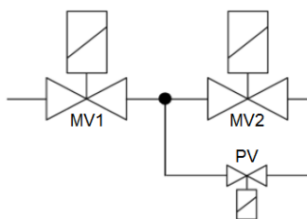

NOTE: to allow a 3-valve configuration, an external SPDT relay needs to be added, when used in combination with VPS. See schematic drawing below.

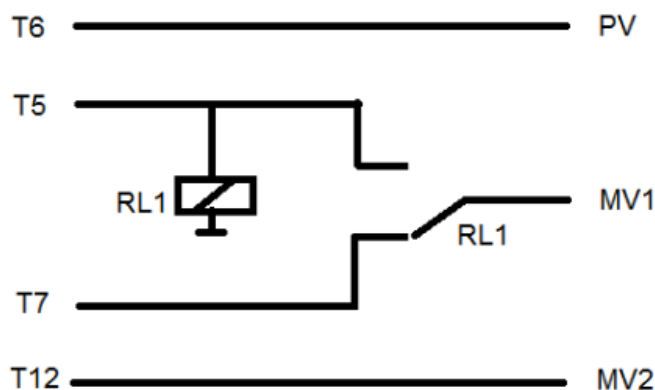

Calculation of the minimum test time (per valve) in a DN80 flanged pipe train, where a 1" bypass valve is used.

- P_i = 150 mbar
 Q_m = 100 dm³/h
 Gas valves used: DN80 size with 1 meter pipe (L1).
 Bypass valve: 1" valve with 0.5 meter pipe (L2).
 To be calculated: T_p [s]

Calculation:

From Table a. :

$$\text{DN80 @ } L1=1\text{m} \rightarrow V_{p1} = 6.9 \text{ dm}^3$$

$$1" \text{ @ } L2=0.5\text{m} \rightarrow V_{p2} = 0.44 \text{ dm}^3$$

There is only 1" bypass valve, that reduces the total volume by 0.5x the volume @ $L=0\text{m} \rightarrow V_{p3} = 0.19 \text{ dm}^3$

$$V_p = V_{p1} + V_{p2} - (0.5 \times V_{p3}) = 7.245 \text{ dm}^3$$

$$T_p = \frac{2 \times 150 \times 7.15}{100} \text{ [s]}$$

Using the formula above, the minimum test time T_p = **21.735s**
 The DBC2000E2 must be set to 25s test time (see page 11).

Table a.

Volumes in dm³ for gas valves like Honeywell VE-series (Vp) with pipe length L (including V1 and V2). For combi blocks, like VQ-M series and direct linked valves, use the values shown under L=0m.

Diameter	Length between valves [m]					
	0	0.5	1	1.5	2	per extra meter
1/4"	0.06	0.1	0.14	0.18	0.22	0.08
1/2"	0.06	0.15	0.24	0.33	0.42	0.18
3/4"	0.12	0.28	0.43	0.59	0.74	0.31
1"	0.19	0.44	0.68	0.93	1.2	0.49
1 1/4"	0.69	1.1	1.5	1.9	2.3	0.8
1 1/2"	0.71	1.4	2.0	2.7	3.3	1.3
2"	1.3	2.3	3.3	4.2	5.2	2.0
2 1/2"	2.7	4.4	6.0	7.7	9.3	3.3
3"	2.9	5.4	7.9	10	13	5
DN65	3.2	4.9	7.5	8.2	9.8	3.3
DN80	4.4	6.9	9.4	12	14	5.0
DN100	6.5	10.5	14.4	18	22	7.9

Threaded connections: sizes in inches.

Flanged connections: sizes in DN

If L = 0m it means that valves are directly linked without pipe connections. Also applicable for combi-blocks (VQ-M series).

Fig 14a. VPS-pre normal operation for PILOT IGNITION configuration.

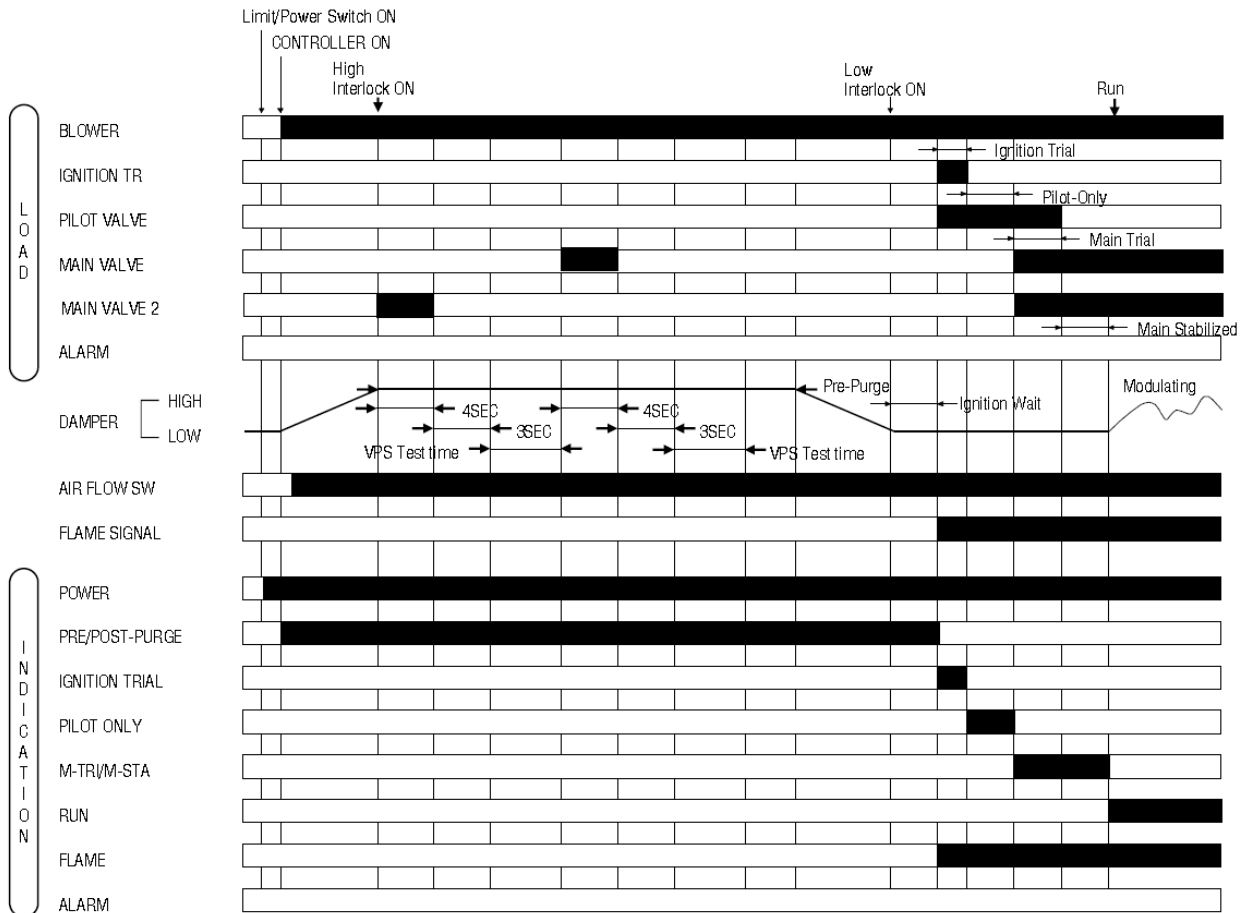

Fig 14b. VPS-pre normal operation for DBI configuration.

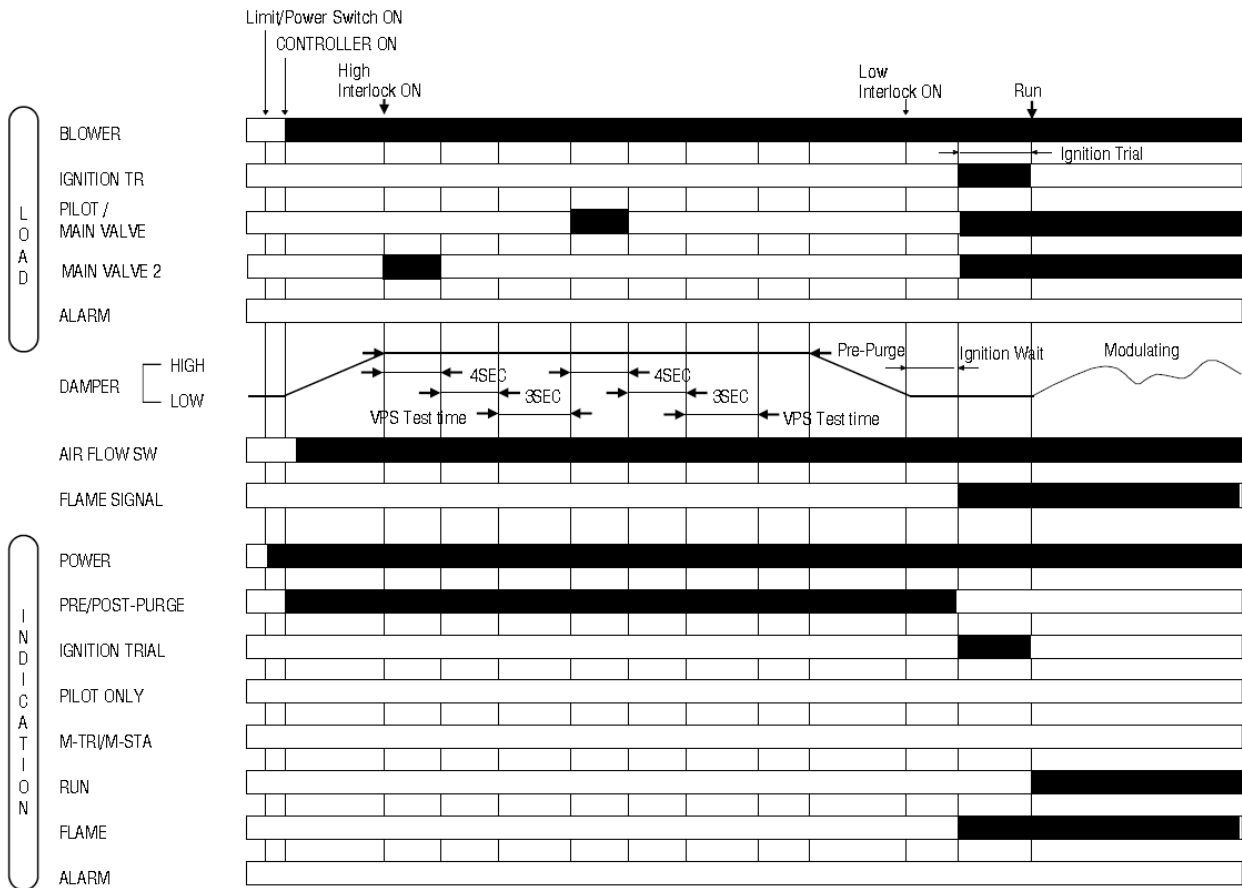

Fig 15a. Normal operation with VPS-After: **POST-PURGE** configuration.

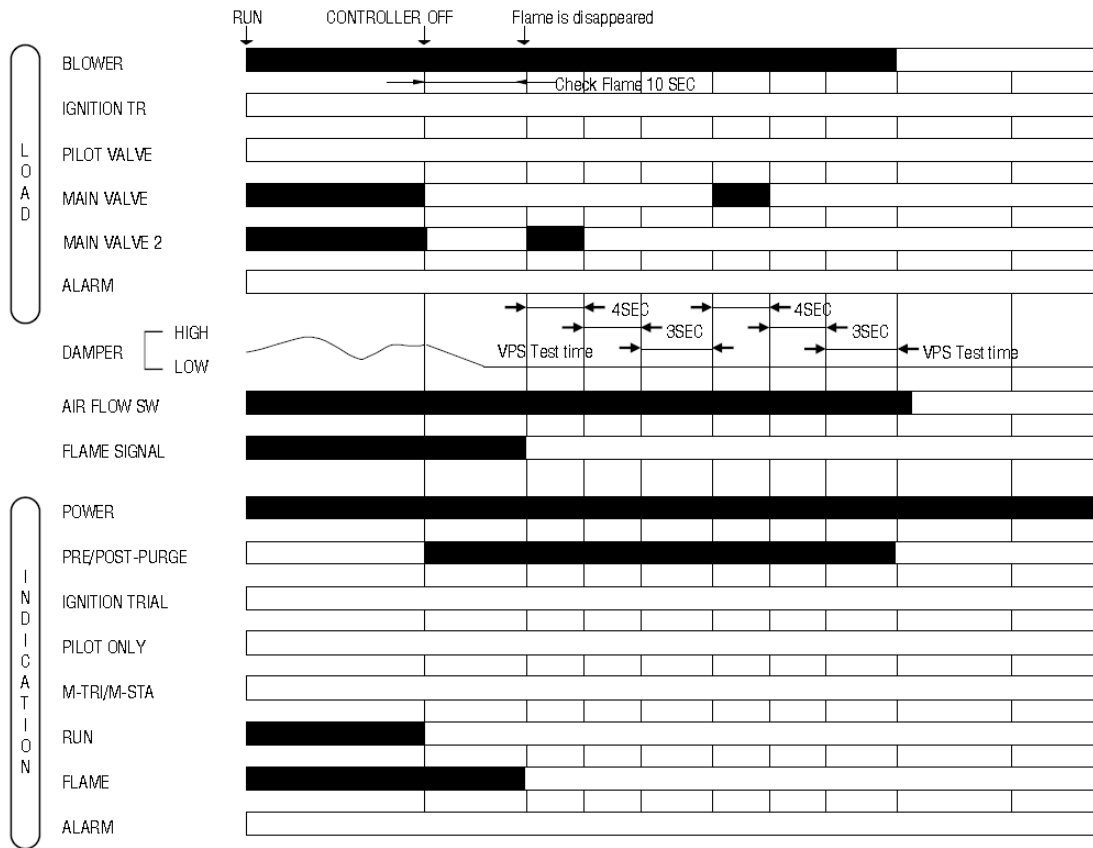

Fig 15b. Normal operation with VPS-After: **NO-POST-PURGE** configuration.

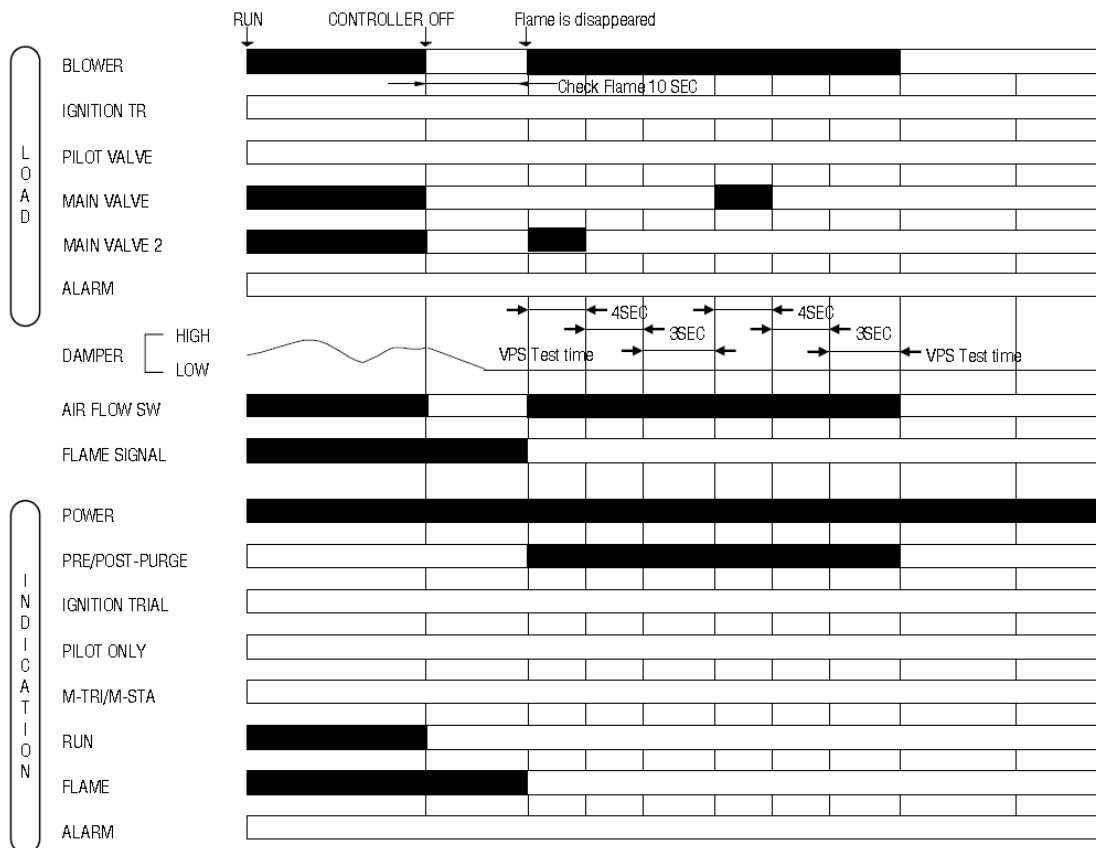

Fig 16a. VPS-pre if valve 1 fails: **PILOT IGNITION** configuration.

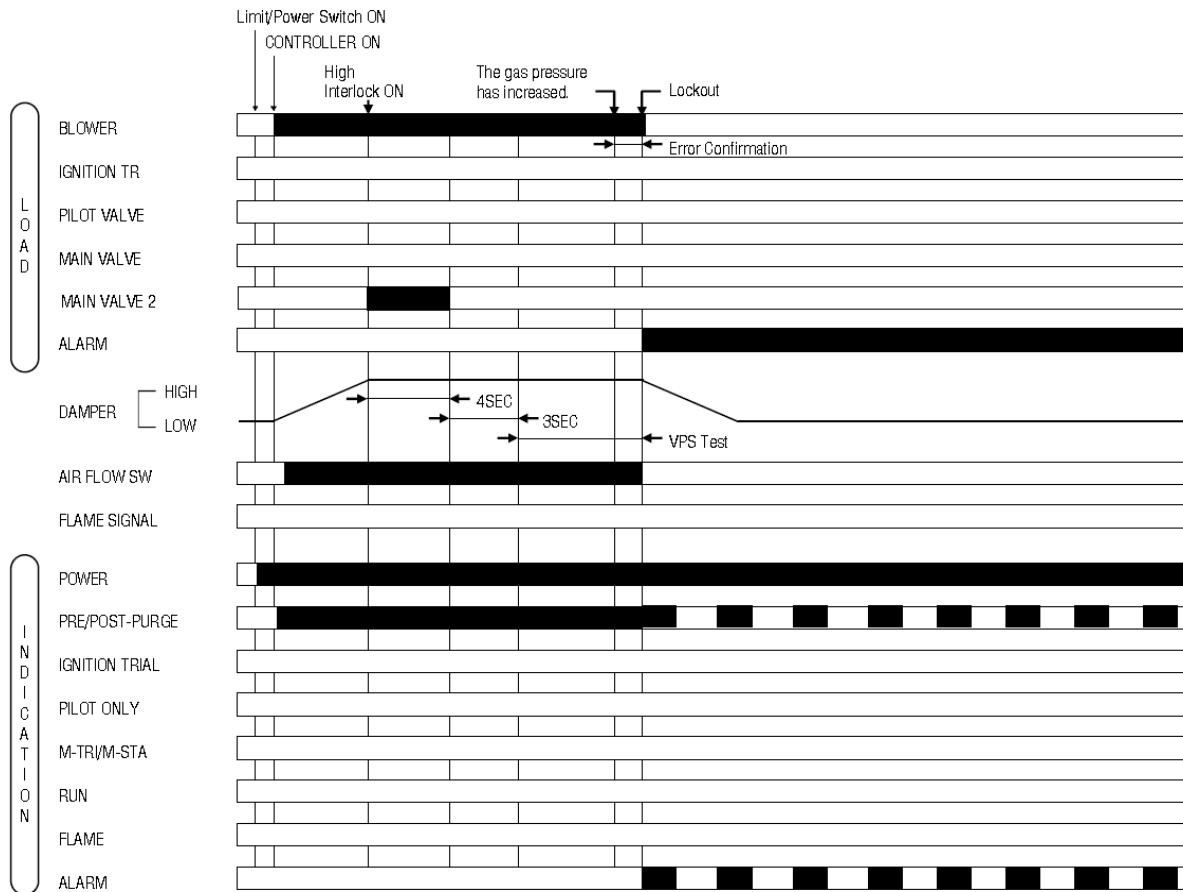

Fig 16b. VPS-pre if valve 1 fails: **DBI** configuration.

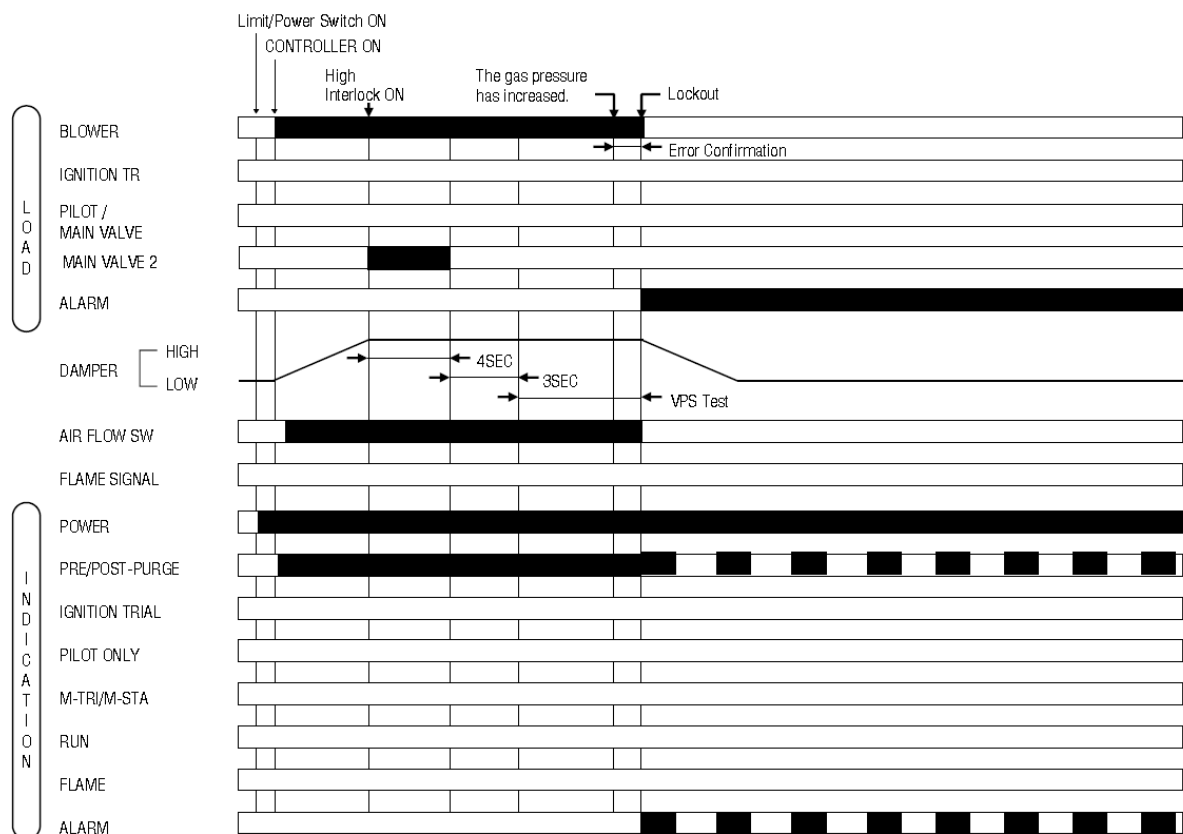

Fig 17a. VPS-pre if valve 2 fails: **PILOT IGNITION** configuration.

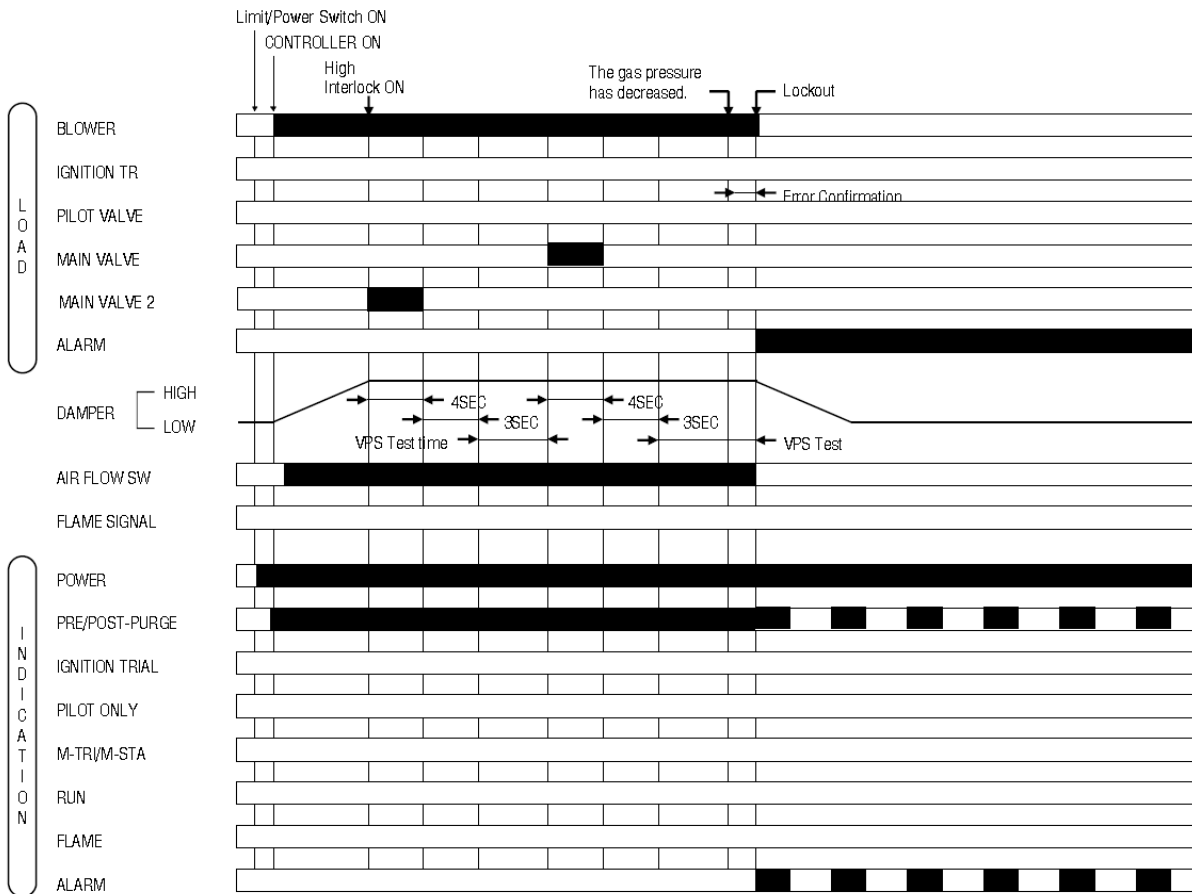

Fig 17b. VPS-pre if valve 2 fails: **DBI** configuration.

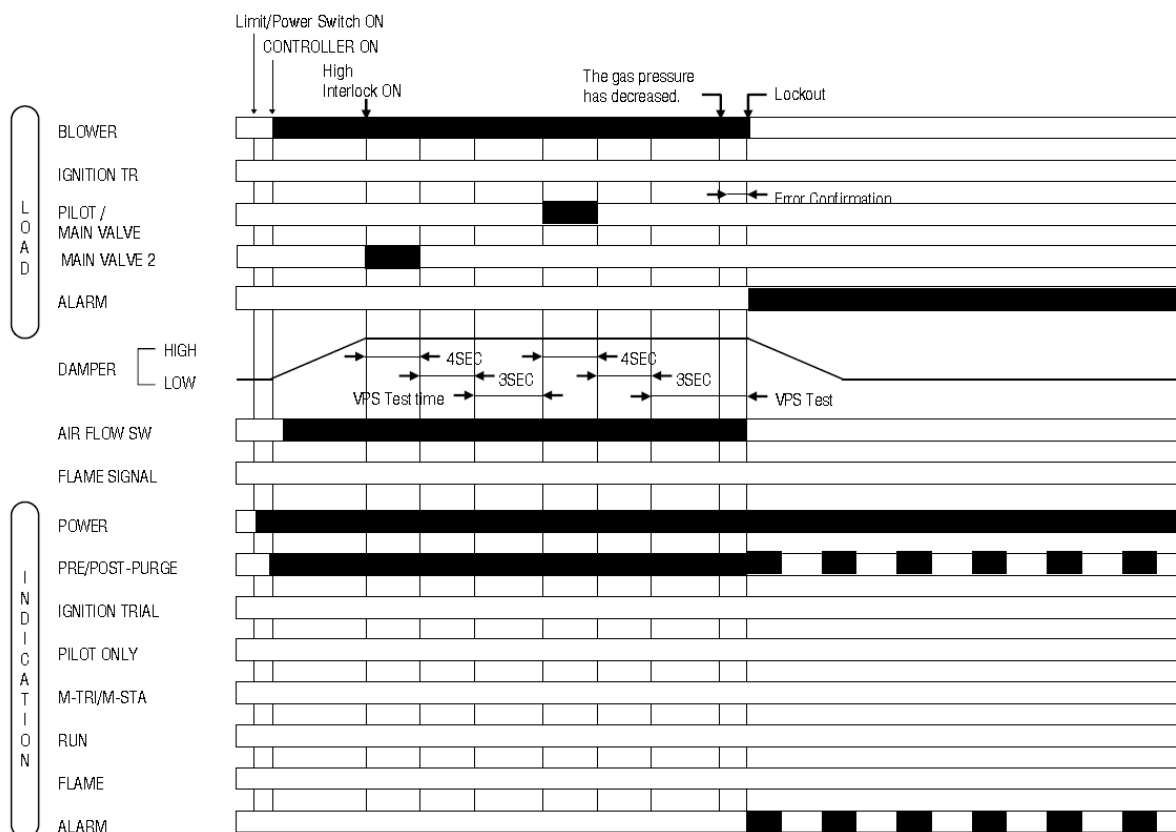

Fig 18a VPS-post normal operation for **PILOT IGNITION** configuration.

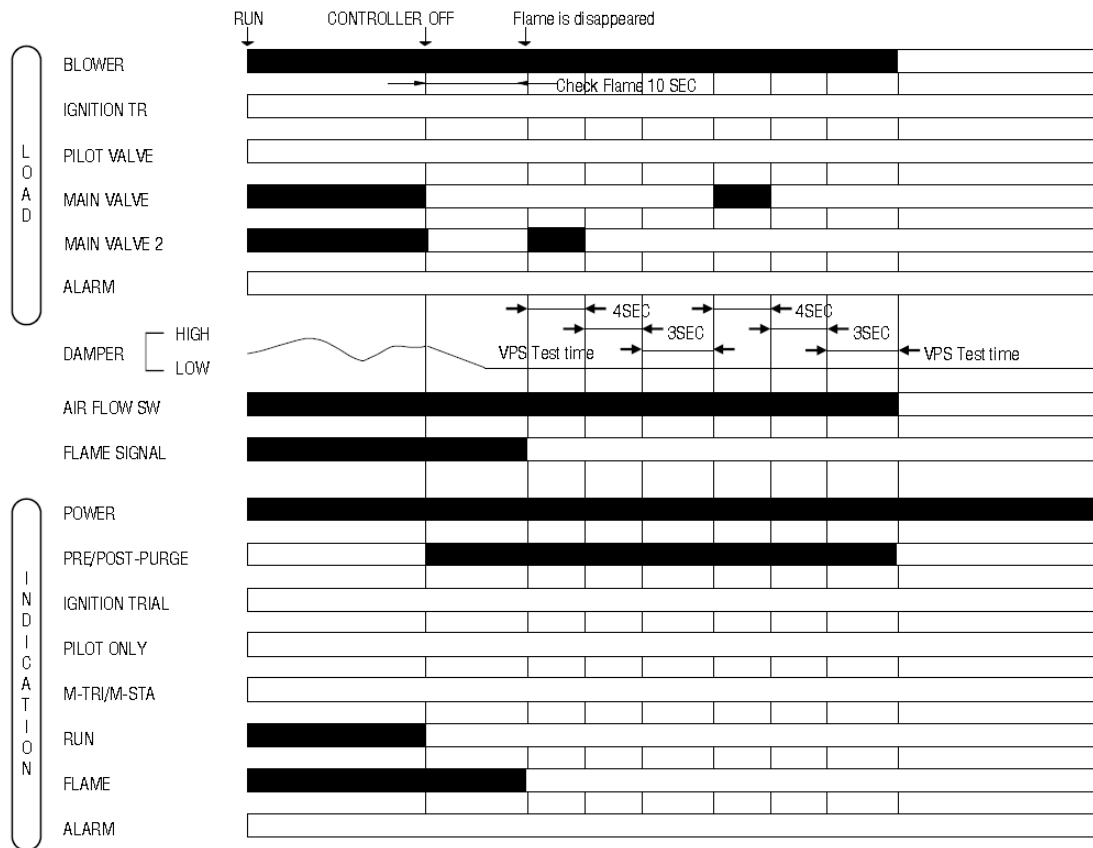

Fig 18b. VPS-post normal operation for **DBI** configuration.

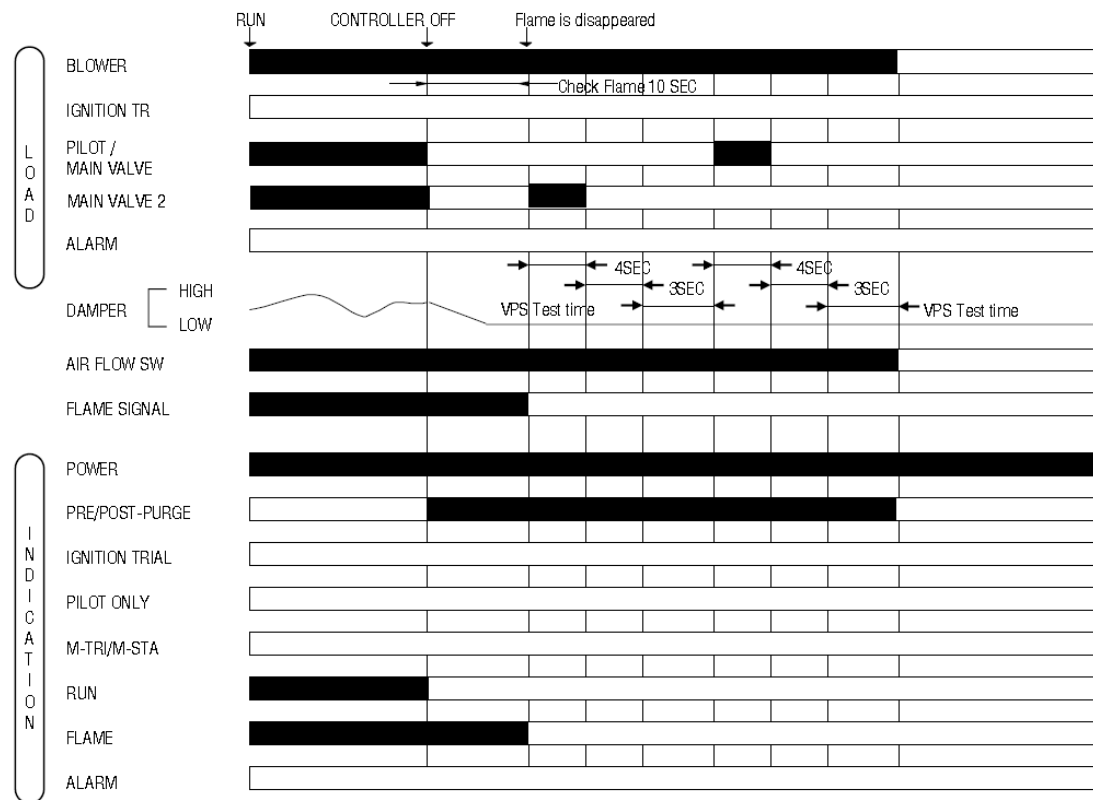

Fig 19a VPS-post if valve 1 fails for **PILOT IGNITION** configuration.

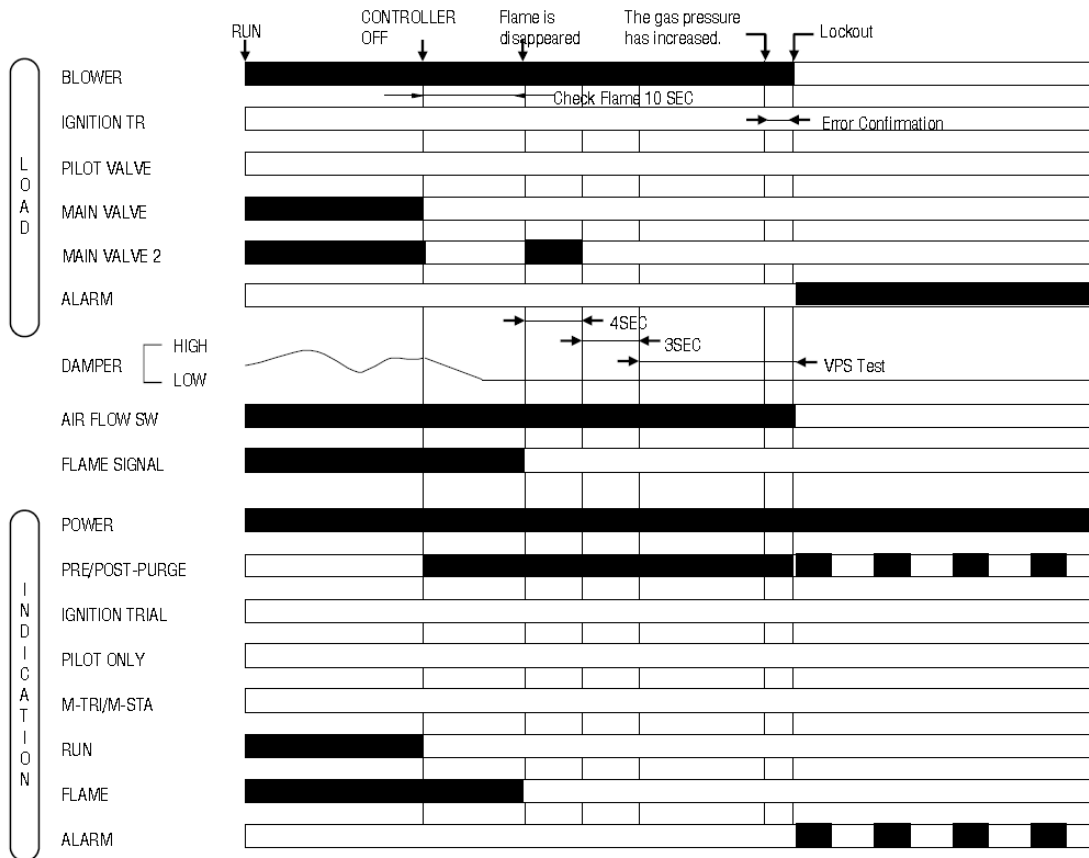

Fig 19b VPS-post if valve 1 fails for **DBI** configuration.

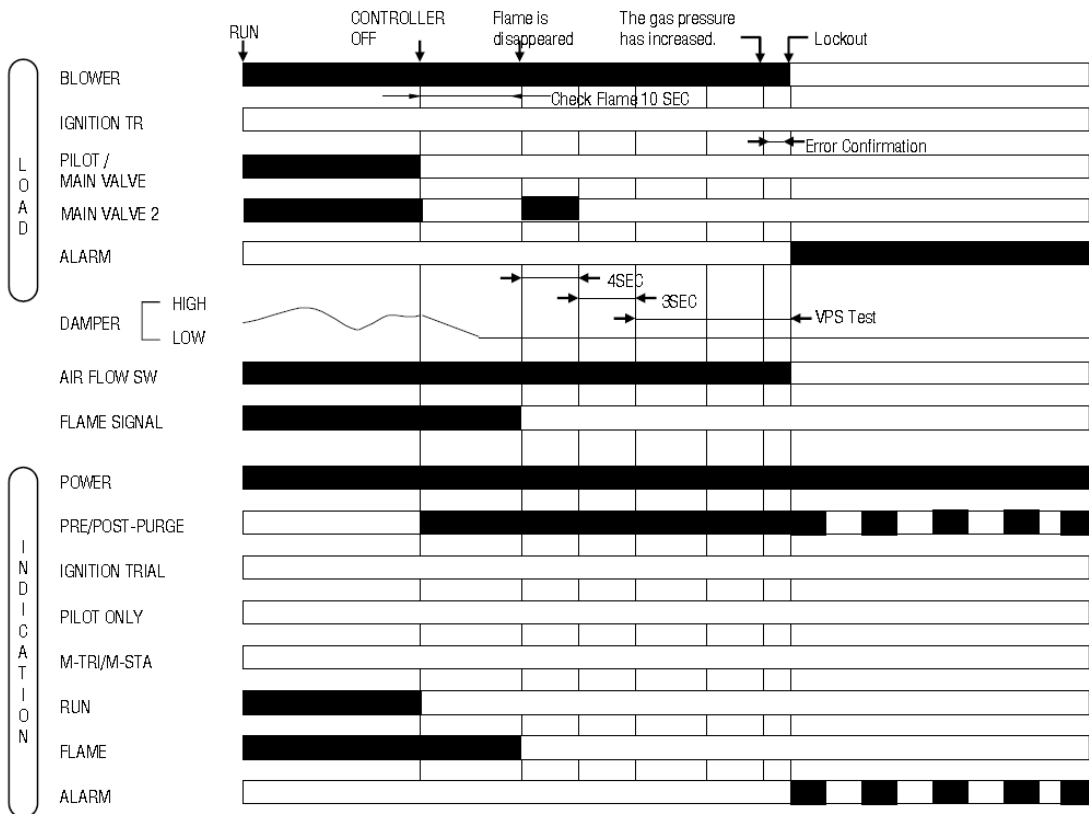

Fig 20a. VPS-post if valve 2 fails for **PILOT IGNITION** configuration.

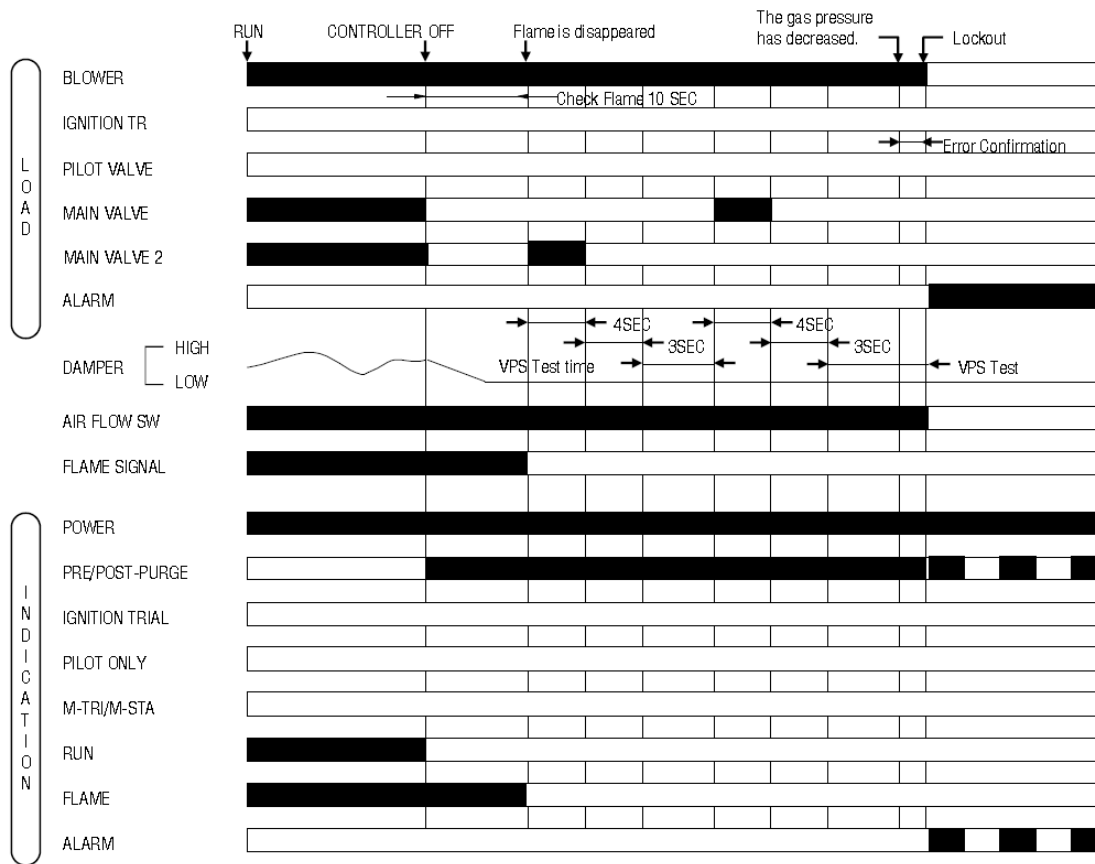
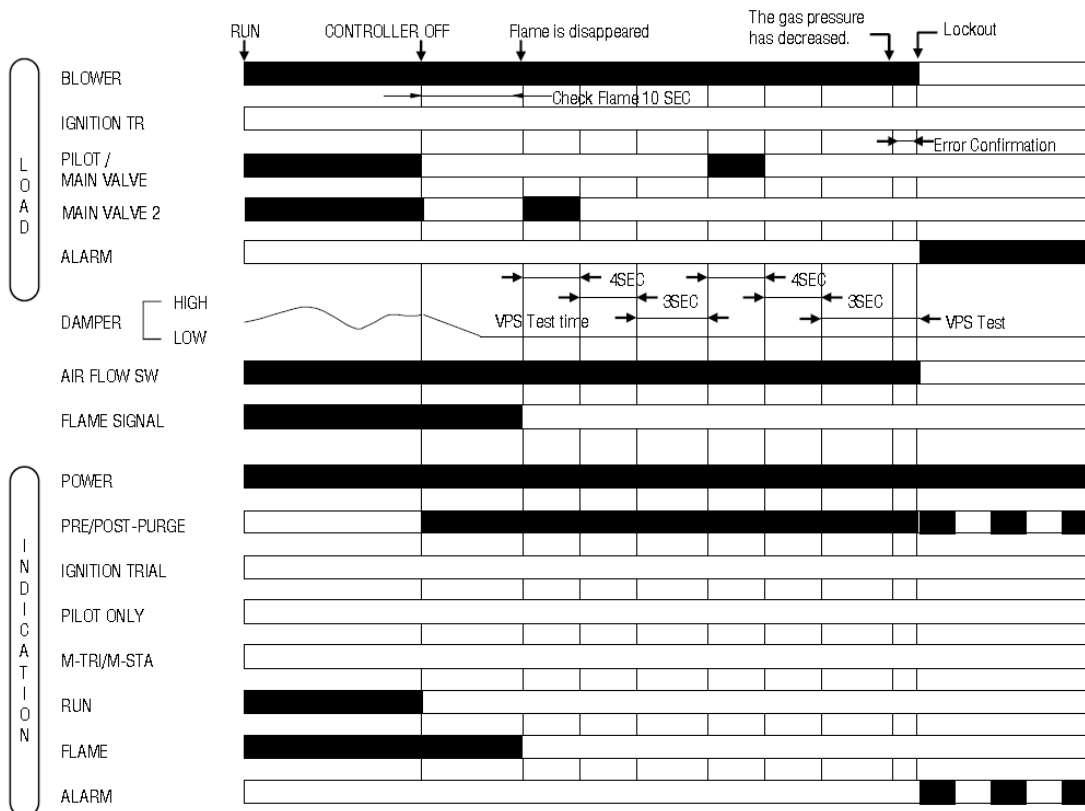

Fig 20b. VPS-post if valve 2 fails for **DBI** configuration.



(Page intentionally left empty)

Honeywell Industrial Combustion

Luchthavenlaan 16
1800 Vilvoorde
Belgium
<http://hic.emea.honeywell.com>